

Two-Way Flat Slab (Concrete Floor System with Drop Panels) Analysis and Design (CAC Design Handbook)

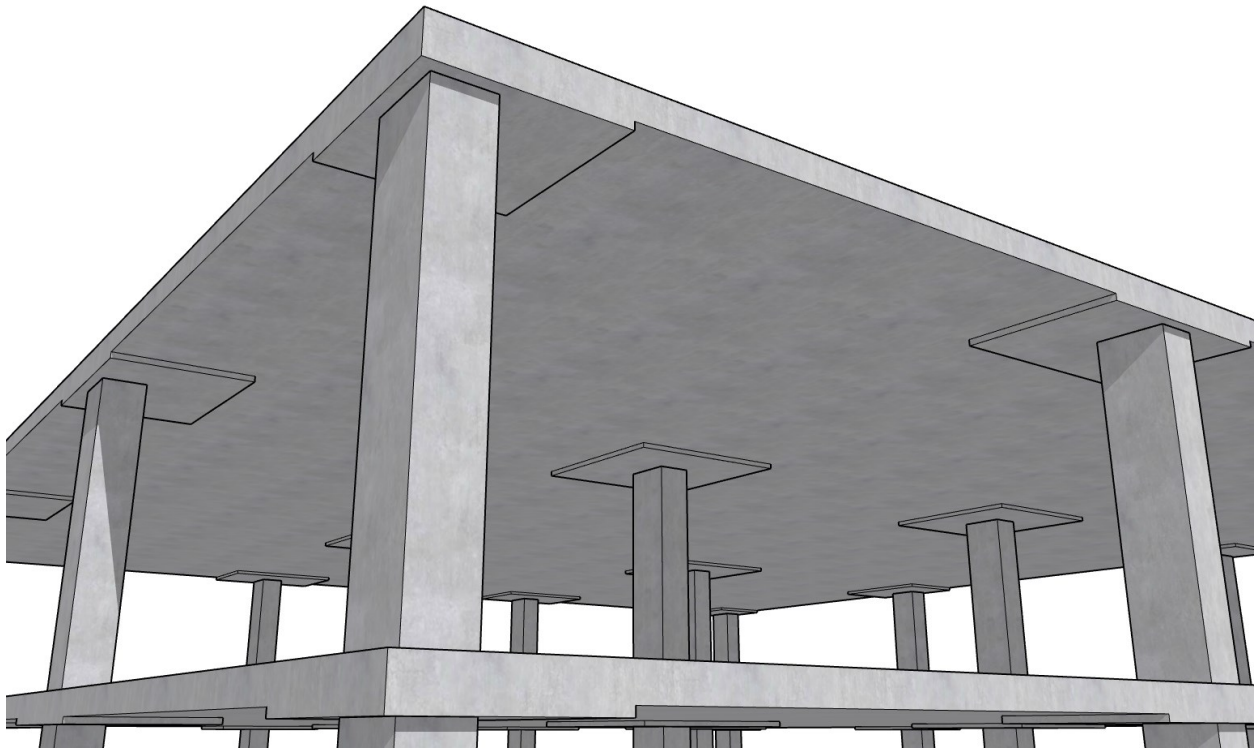

Two-Way Flat Slab (Concrete Floor System with Drop Panels) Analysis and Design (CAC Design Handbook)

The concrete floor slab system shown below is for an intermediate floor to be designed considering partition weight = 1 kN/m² and mechanical services load = 1 kN/m², and unfactored live load = 3.6 kN/m². The lateral loads are independently resisted by shear walls. The use of flat plate system will be checked. If the use of flat plate is not adequate, the use of flat slab system with drop panels will be investigated. Flat slab concrete floor system is similar to the flat plate system. The only exception is that the flat slab uses drop panels (thickened portions around the columns) to increase the nominal shear strength of the concrete at the critical section around the columns. The analysis procedure “Elastic Frame Method (EFM)” prescribed in CSA A23.3-14 is illustrated in detail in this example (Example #2 from the CAC Design Handbook). The hand solution from EFM is also used for a detailed comparison with the Reference results using Direct Design Method (DDM) and results of the engineering software program [spSlab](#). Explanation of the EFM is available in [StructurePoint Video Tutorials](#) page.

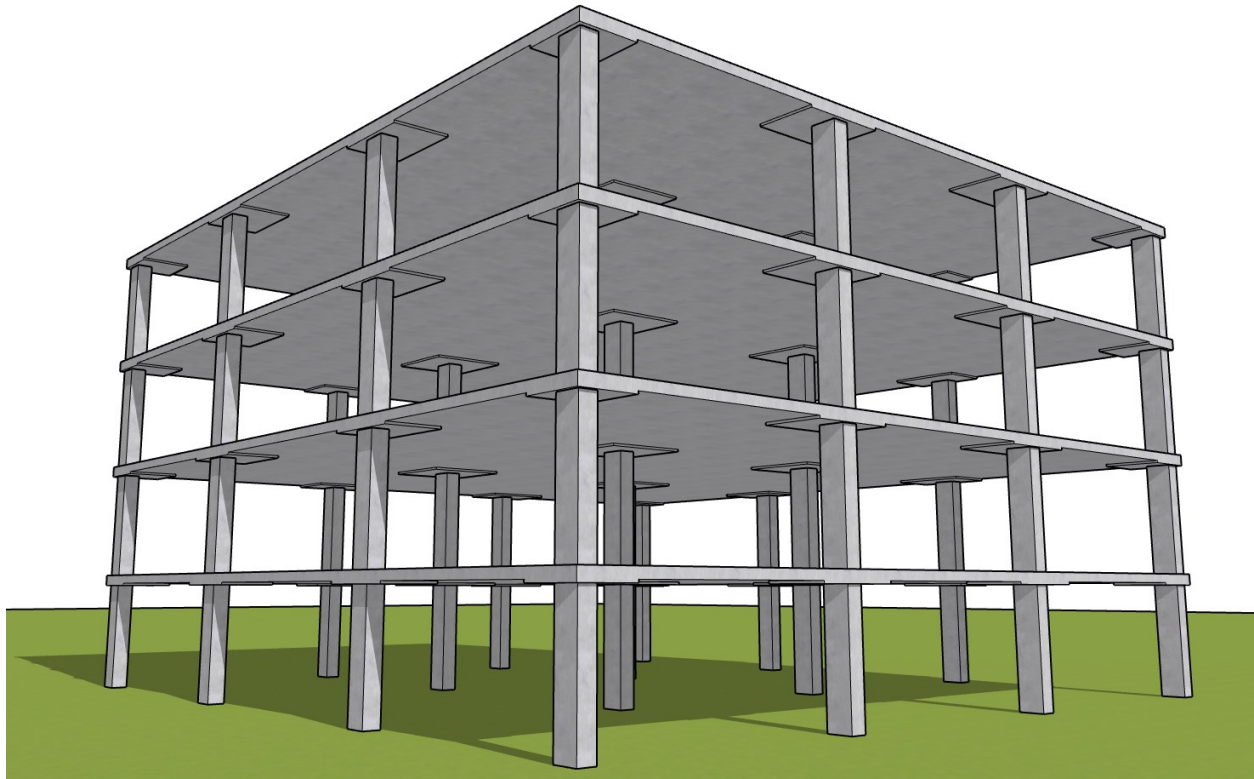
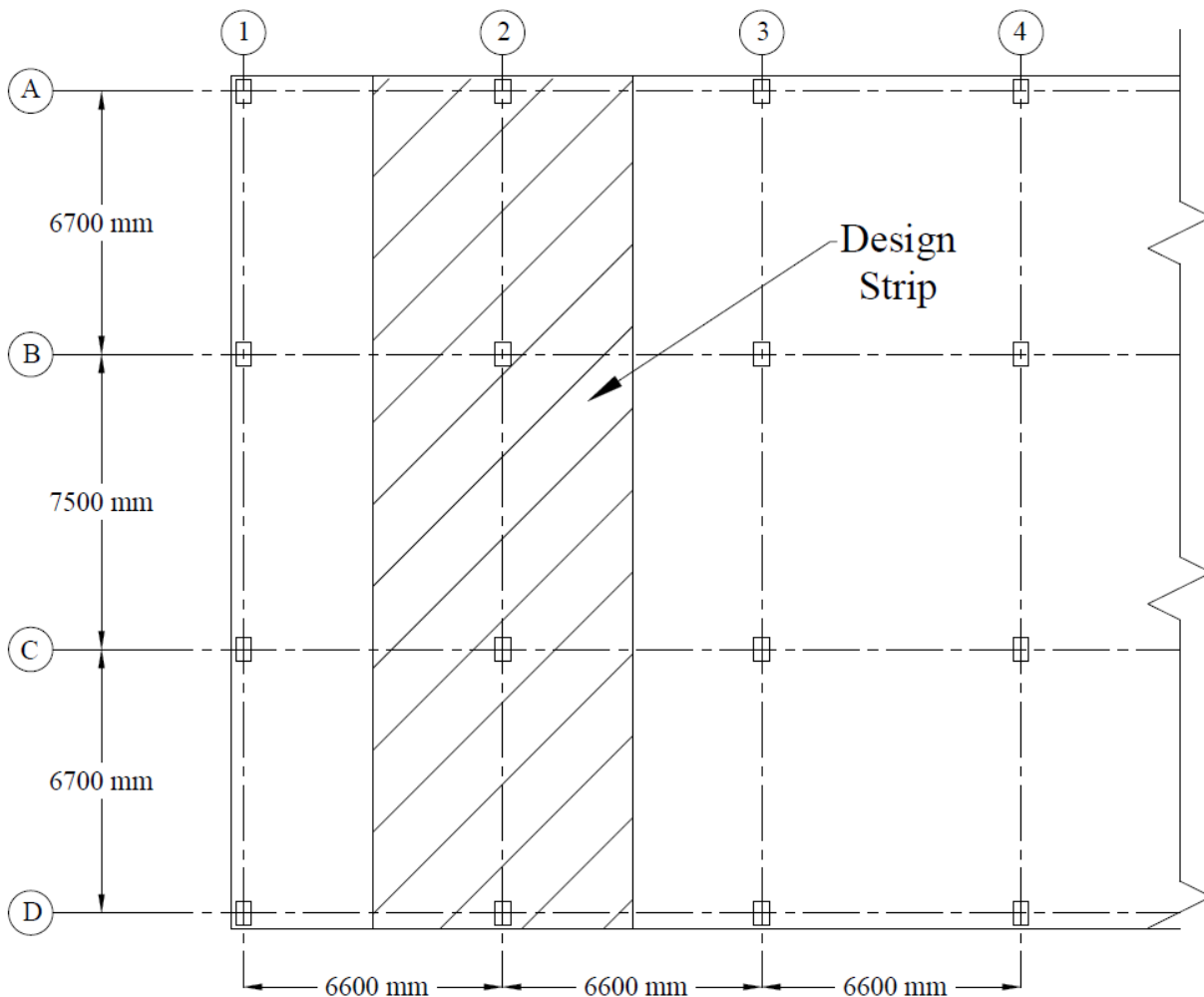

Figure 1 - Two-Way Flat Concrete Floor System

Contents

1. Preliminary member sizing	1
2. Flexural Analysis and Design.....	13
2.1. Direct Design Method (DDM)	14
2.1.1. Direct design method limitations.....	14
2.2. Elastic Frame Method (EFM)	15
2.2.1. Limitations for use of elastic frame method	17
2.2.2. Frame members of elastic frame	17
2.2.3. Elastic frame analysis	21
2.2.4. Factored moments used for Design	23
2.2.5. Distribution of design moments	24
2.2.6. Flexural reinforcement requirements.....	25
2.2.7. Factored moments in columns	29
3. Shear Strength	30
3.1. One-Way (Beam action) Shear Strength	30
3.1.1. At distance d_v from the supporting column	30
3.1.2. At the face of the drop panel	31
3.2. Two-Way (Punching) Shear Strength	32
3.2.1. Around the columns faces	32
3.2.2. Around drop panels	34
4. Serviceability Requirements (Deflection Check)	37
5. spSlab Software Program Model Solution	38
6. Summary and Comparison of Design Results.....	64
7. Conclusions & Observations	66
7.1. One-Way Shear Distribution to Slab Strips	66
7.2. Two-Way Concrete Slab Analysis Methods	69

Code

Design of Concrete Structures (CSA A23.3-14) and Explanatory Notes on CSA Group standard A23.3-14
“Design of Concrete Structures”

Reference

CAC Concrete Design Handbook, 4th Edition, Cement Association of Canada, Chapter 5, Example 2

Design Data

Floor-to-Floor Height = 3 m (provided by architectural drawings)

Superimposed Dead Load, $SDL = 1 \text{ kN/m}^2$ for framed partitions, wood studs plaster 2 sides
 $= 1 \text{ kN/m}^2$ for mechanical services

Live Load, $LL = 3.6 \text{ kN/m}^2$ for Residential floors

$f'_c = 25 \text{ MPa}$ (for slabs and columns)

$f'_y = 400 \text{ MPa}$

Column Dimensions = 400 mm x 600 mm

Solution

1. Preliminary member sizing

For slabs without Drop Panels

1.1 Slab minimum thickness - Deflection

CSA A23.3-14 (13.2)

Minimum member thickness and depths from CSA A23.3-14 will be used for preliminary sizing.

Using CSA A23.3-14 minimum slab thickness for two-way construction without interior beams in **Section 13.2.3**.

Exterior Panels (N-S Direction Governs):

$$h_{s,\min} = 1.1 \times \frac{l_n (0.6 + f'_y / 1000)}{30} = 1.1 \times \frac{6200 (0.6 + 400 / 1000)}{30} = 227 \text{ mm} \quad \text{CSA A23.3-14 (13.2.3)}$$

But not less than 120 mm. CSA A23.3-14 (13.2.1)

Where l_n = length of clear span in the long direction = 6600 – 400 = 6200 mm

Interior Panels (E-W Direction Governs):

$$h_{s,\min} = \frac{l_n (0.6 + f_y / 1000)}{30} = \frac{6900(0.6 + 400 / 1000)}{30} = 230 \text{ mm} \quad \text{CSA A23.3-14 (13.2.3)}$$

But not less than 120 mm.

CSA A23.3-14 (13.2.1)

Where l_n = length of clear span in the long direction = 7500 – 600 = 6900 mm

Try 250 mm slab for all panels (self-weight = 5.89 kN/m²)

1.2. Slab one way shear strength

Evaluate the average effective depth (Figure 2):

$$d_t = t_{\text{slab}} - c_{\text{clear}} - d_b - \frac{d_b}{2} = 250 - 25 - 16 - \frac{16}{2} = 201 \text{ mm}$$

$$d_l = t_{\text{slab}} - c_{\text{clear}} - \frac{d_b}{2} = 250 - 25 - \frac{16}{2} = 217 \text{ mm}$$

$$d_{\text{avg}} = \frac{d_l + d_t}{2} = \frac{201 + 217}{2} = 209 \text{ mm}$$

Where:

$c_{\text{clear}} = 20 \text{ mm}$ for 15M steel bar

CSA A23.3-14 (Annex A. Table 17)

Note that the reference used 25 mm as clear cover, in this example the clear cover used is 25 mm to be consistent with reference.

$d_b = 16 \text{ mm}$ for 15M steel bar

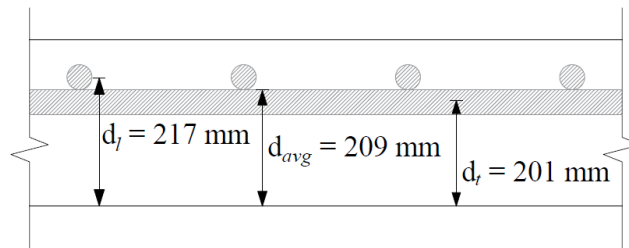

Figure 2 - Two-Way Flat Concrete Floor System

Load Combination 1:

Factored dead load, $w_{df} = 1.4 \times (5.89 + 1 + 1) = 11.05 \text{ kN/m}^2$ CSA A23.3-14 (Annex C. Table C.1 a)

Total factored load $w_f = 11.05 \text{ kN/m}^2$

Load Combination 2:

Factored dead load, $w_{df} = 1.25 \times (5.89 + 1 + 1) = 9.86 \text{ kN/m}^2$

Factored live load, $w_{lf} = 1.5 \times 3.6 = 5.40 \text{ kN/m}^2$ CSA A23.3-14 (Annex C. Table C.1 a)

Total factored load $w_f = w_{df} + w_{lf} = 15.26 \text{ kN/m}^2$ (Controls)

Check the adequacy of slab thickness for beam action (one-way shear) CSA A23.3-14 (13.3.6)

At an interior column:

The critical section for one-way shear is extending in a plane across the entire width and located at a distance, d_v from the face of support or concentrated load (see Figure 3). CSA A23.3-14 (13.3.6.1)

Consider a 1 m. wide strip.

$$\text{Tributary area for one-way shear is } A_{Tributary} = \left(\frac{\left[\left(\frac{7500}{2} \right) - \left(\frac{600}{2} \right) - 209 \right] \times (1000)}{1000^2} \right) = 3.26 \text{ m}^2$$

$$V_f = w_f \times A_{Tributary} = 15.26 \times 3.26 = 49.75 \text{ kN}$$

$$V_c = \phi_c \lambda \beta \sqrt{f'_c} b_w d_v \quad \text{CSA A23.3-14 (Eq. 11.6)}$$

Where:

$$\lambda = 1 \text{ for normal weight concrete} \quad \text{CSA A23.3-14 (8.6.5)}$$

$$\beta = 0.21 \text{ for slabs with overall thickness not greater than 350 mm} \quad \text{CSA A23.3-14 (11.3.6.2)}$$

$$d_v = \text{Max} (0.9d_{avg}, 0.72h) = \text{Max} (0.9 \times 209, 0.72 \times 250) = \text{Max} (188, 180) = 188 \text{ mm} \quad \text{CSA A23.3-14 (3.2)}$$

$$\sqrt{f'_c} = 5 \text{ MPa} < 8 \text{ MPa} \quad \text{CSA A23.3-14 (11.3.4)}$$

$$V_c = 0.65 \times 1 \times 0.21 \times \sqrt{25} \times 1000 \times \frac{188}{1000} = 128.3 \text{ kN} > V_f$$

Slab thickness of 250 mm is adequate for one-way shear.

1.3. Slab two-way shear strength

Check the adequacy of slab thickness for punching shear (two-way shear) at an interior column (Figure 4):

$$\text{Shear perimeter: } b_0 = 2 \times (600 + 400 + 2 \times 209) = 2836 \text{ mm} \quad \text{CSA A23.3-14 (13.3.3)}$$

Tributary area for two-way shear is

$$A_{Tributary} = \left(\frac{7.5 + 6.7}{2} \times 6.6 \right) - \left(\frac{600 + 209}{1,000} \times \frac{400 + 209}{1,000} \right) = 46.86 - 0.49 = 46.37 \text{ m}^2$$

The factored resisting shear stress, V_r shall be the smallest of: CSA A23.3-14 (13.3.4.1)

$$a) \quad v_r = v_c = \left(1 + \frac{2}{\beta_c}\right) 0.19 \lambda \phi_c \sqrt{f'_c} \quad \text{CSA A23.3-14 (Eq. 13.5)}$$

$$v_r = \left(1 + \frac{2}{1.5}\right) \times 0.19 \times 0.65 \times \sqrt{25} = 1.44 \text{ MPa}$$

$$\text{Where } \beta_c = \frac{600}{400} = 1.5 \text{ (ratio of long side to short side of the column)} \quad \text{CSA A23.3-14 (13.3.4.1)}$$

$$b) \quad v_r = v_c = \left(\frac{\alpha_s d}{b_o} + 0.19\right) \lambda \phi_c \sqrt{f'_c} \quad \text{CSA A23.3-14 (Eq. 13.6)}$$

$$v_r = \left(\frac{4 \times 209}{2836} + 0.19\right) \times 1 \times 0.65 \times \sqrt{25} = 1.58 \text{ MPa}$$

$$c) \quad v_r = v_c = 0.38 \lambda \phi_c \sqrt{f'_c} = 0.38 \times 1 \times 0.65 \times \sqrt{25} = 1.24 \text{ MPa} \quad \text{CSA A23.3-14 (Eq. 13.7)}$$

$$v_{f,ave} = \frac{V_f}{b_o d} = \frac{15.26 \times \left(\frac{7.5 + 6.7}{2} \times 6.6\right)}{2836 \times 209} \times 1,000 = 1.206 \text{ MPa}$$

$$\frac{v_r}{v_{f,ave}} = \frac{1.240}{1.206} = 1.03 < 1.20 \text{ (No Good)} \quad \text{CAC Concrete Design Handbook 4th Edition (5.2.3)}$$

Slab thickness of 250 mm is **NOT** adequate for two-way shear.

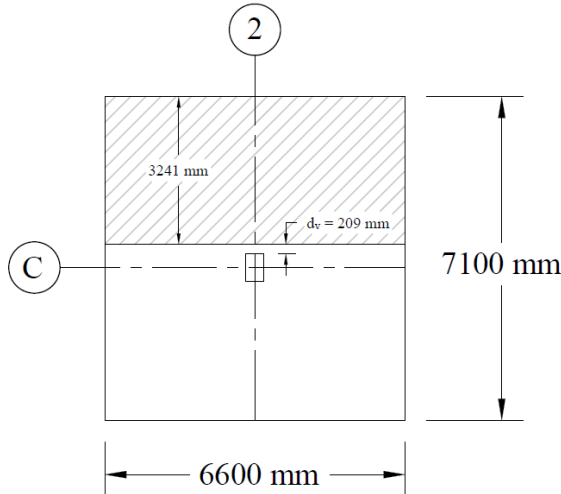

Figure 3 - Critical Section for One-Way

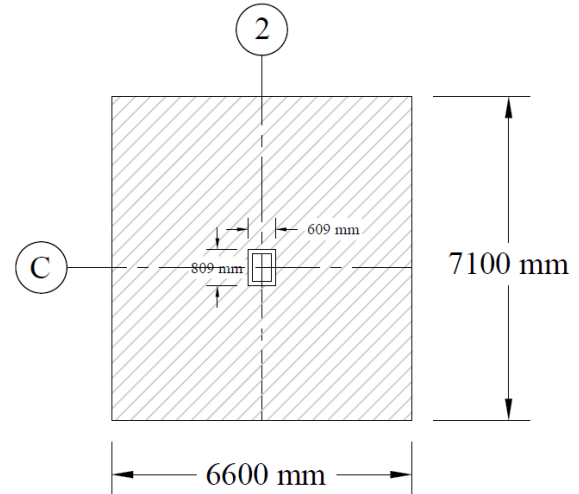

Figure 4 - Critical Section for Two-Way

In this case, four options could be used: 1) to increase the slab thickness, 2) to increase columns cross sectional dimensions or cut the spacing between columns (reducing span lengths), however, this option is assumed to be not permissible in this example due to architectural limitations, 3) to use headed shear reinforcement, or 4) to use drop panels. In this example, the latter option will be used to achieve better understanding for the design of two-way slab with drop panels often called flat slab.

Check the drop panel dimensional limitations as follows:

- 1) The additional thickness of the drop panel below the soffit of the slab (Δ_h) shall not be taken larger than h_s .

CSA A23.3-14 (13.2.4)

Since the slab thickness (h_s) is 220 mm (see page 7), the thickness of the drop panel should be less than 220 mm.

Drop panel dimensions are also controlled by formwork considerations. The following Figure shows the standard lumber dimensions that are used when forming drop panels. Using other depths will unnecessarily increase formwork costs. The Δ_h dimension will be taken as the lumber dimension plus the thickness of one sheet of plywood (19 mm).

For nominal lumber size:

$$h_{dp} = 38 + 19 = 57 \text{ mm or } h_{dp} = 89 + 19 = 108 \text{ mm}$$

Try $h_{dp} = 57 \text{ mm} < 220 \text{ mm}$

The total thickness including the slab and the drop panel (h) = $h_s + h_{dp} = 220 + 57 = 277 \text{ mm}$

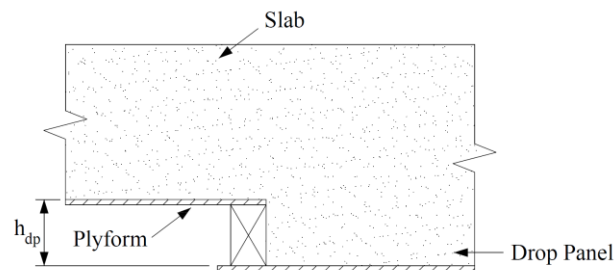

Nominal Lumber Size, mm	Actual Lumber Size, mm	Plyform Thickness, mm	h_{dp} , mm
2x	38	19	57
4x	89	19	108

Figure 5 – Drop Panel Formwork Details

- 2) Drop panel size:

$$h_s = \frac{l_n (0.6 + f_y / 1,000)}{30} - \frac{2x_d}{l_n} \quad \text{CSA A23.3-14 (13.2.4)}$$

Rearrange the previous equation

$$x_d = \left(\frac{l_n (0.6 + f_y / 1000)}{30} - h_s \right) \times l_n = \left(\frac{(7500 - 600)(0.6 + 400 / 1000)}{30} - 220 \right) \times (7500 - 600) = 605 \text{ mm}$$

Minimum length of drop panel = $2(605) + 600 = 1810 \text{ mm} \rightarrow$ Try 2000 mm x 2000 mm

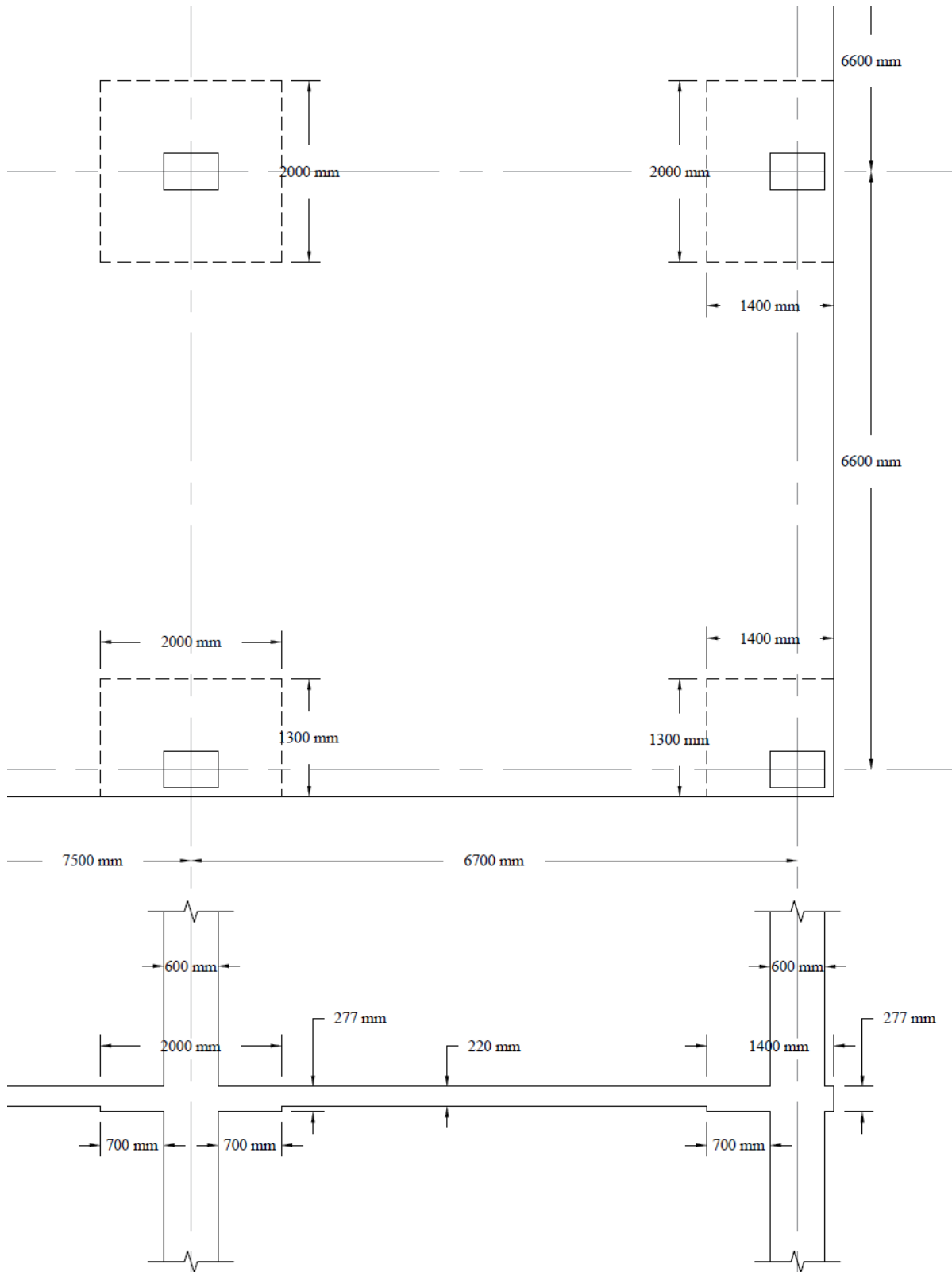

Figure 6 – Drop Panels Dimensions

For Flat Slab (with Drop Panels)

For slabs with changes in thickness and subjected to bending in two directions, it is necessary to check shear at multiple sections as defined in the **CSA A23.3-14**. The critical sections for two-way action shall be located with respect to:

- 1) Perimeter of the concentrated load or reaction area. **CSA A.23.3-14 (13.3.3.1)**
- 2) Changes in slab thickness, such as edges of drop panels. **CSA A.23.3-14 (13.3.3.2)**

a. **Slab minimum thickness – Deflection**

In lieu of detailed calculation for deflections, CSA A23.3 Code gives minimum slab thickness for two-way construction with drop panel in ***Clause 13.2.4***.

The value of $2x_d/l_n$ is not known at this point. The upper limit is 1/4. A reasonable preliminary estimate is 1/6.

Exterior Panel:
$$h_{s,\min} = 1.1 \times \left(\frac{l_n (0.6 + f_y / 1,000)}{30} - \frac{2x_d}{l_n} \times \Delta_h \right) \quad \text{CSA A23.3-14 (13.2.4)}$$

$$h_{s,\min} = 1.1 \times \left(\frac{(6700 - 600)(0.6 + 0.4)}{30} - \frac{2}{6} \times 57 \right) = 203 \text{ mm}$$

But not less than 120 mm. **CSA A23.3-14 (13.2.1)**

Interior Panel:
$$h_{s,\min} = \frac{l_n (0.6 + f_y / 1,000)}{30} - \frac{2x_d}{l_n} \times \Delta_h \quad \text{CSA A23.3-14 (13.2.4)}$$

$$h_{s,\min} = \frac{(7500 - 600)(0.6 + 0.4)}{30} - \frac{2}{6} \times 57 = 211 \text{ mm}$$

But not less than 120 mm. **CSA A23.3-14 (13.2.1)**

Try 220 mm slab for all panels (277 mm with drop panels)

Self-weight for slab section without drop panel = $24 \text{ kN/m}^3 \times 0.220 \text{ m} = 5.28 \text{ kN/m}^2$

Self-weight for slab section with drop panel = $24 \text{ kN/m}^3 \times 0.277 \text{ m} = 6.65 \text{ kN/m}^2$

b. **Slab shear strength – one way shear**

For critical section at distance d from the edge of the column (slab section with drop panel):

Evaluate the average effective depth:

$$d_t = h_s - c_{\text{clear}} - d_b - \frac{d_b}{2} = 277 - 25 - 16 - \frac{16}{2} = 228 \text{ mm}$$

$$d_l = h_s - c_{\text{clear}} - \frac{d_b}{2} = 277 - 25 - \frac{16}{2} = 244 \text{ mm}$$

$$d_{avg} = \frac{d_t + d_l}{2} = \frac{228 + 244}{2} = 236 \text{ mm}$$

Where:

$$c_{clear} = 20 \text{ mm}$$

CSA A23.3-14 (Annex A. Table 17)

Note that the reference used 25 mm as clear cover, in this example the clear cover used is 25 mm to be consistent with reference.

$$d_b = 16 \text{ mm for 15M steel bar}$$

$$\text{Factored dead load} \rightarrow w_{df} = 1.25 \times (6.65 + 1 + 1) = 10.81 \text{ kN/m}^2 \quad \text{CSA A23.3-14 (Annex C. Table C.1 a)}$$

$$\text{Factored live load} \rightarrow w_f = 1.5 \times 3.6 = 5.40 \text{ kN/m}^2$$

$$\text{Total factored load} \rightarrow w_f = 10.81 + 5.40 = 16.21 \text{ kN/m}^2$$

Check the adequacy of slab thickness for beam action (one-way shear) from the edge of the interior column

CSA A23.3-14 (13.3.6)

Consider a 1 m wide strip. The critical section for one-way shear is located at a distance d_v , from the edge of the column (see Figure 7)

$$\text{Tributary area for one-way shear is } A_{Tributary} = \left(\frac{\left[\left(\frac{7500}{2} \right) - \left(\frac{600}{2} \right) - 212.4 \right] \times (1000)}{1000^2} \right) = 3.24 \text{ m}^2$$

$$V_f = w_f \times A_{Tributary} = 16.21 \times 3.24 = 52.52 \text{ kN}$$

$$V_c = \phi_c \lambda \beta \sqrt{f'_c} b_w d_v \quad \text{CSA A23.3-14 (Eq. 11.6)}$$

Where $\lambda = 1$ for normal weight concrete

This slab contains no transverse reinforcement and it is assumed the specified nominal maximum size of coarse aggregate is not less than 20 mm, β shall be taken as: CSA A23.3-14 (11.3.6.3)

$$\beta = \frac{230}{(1000 + d_v)} = \frac{230}{(1000 + 212.4)} = 0.190$$

$$d_v = \text{Max} [0.9d, 0.75h] \quad \text{CSA A23.3-14 (3.2)}$$

$$d_v = \text{Max} [0.9(236), 0.75(277)] = \text{Max} [212.4, 207.8] = 212.4 \text{ mm}$$

$$V_c = 0.65 \times 1 \times 0.19 \times \sqrt{25} \times 1000 \times \frac{212.4}{1000} = 131.2 \text{ kN} > V_u$$

Slab thickness of 220 mm is adequate for one-way shear for the first critical section (from the edge of the column).

For critical section at the edge of the drop panel (slab section without drop panel):

Evaluate the average effective depth:

$$d_t = h_s - c_{clear} - d_b - \frac{d_b}{2} = 220 - 25 - 16 - \frac{16}{2} = 171 \text{ mm}$$

$$d_l = h_s - c_{clear} - \frac{d_b}{2} = 220 - 25 - \frac{16}{2} = 187 \text{ mm}$$

$$d_{avg} = \frac{d_t + d_l}{2} = \frac{171 + 187}{2} = 179 \text{ mm}$$

Where:

$$c_{clear} = 20 \text{ mm}$$

CSA A23.3-14 (Annex A. Table 17)

Note that the reference used 25 mm as clear cover, in this example the clear cover used is 25 mm to be consistent with reference.

$$d_b = 16 \text{ mm for 15M steel bar}$$

$$\text{Factored dead load} \rightarrow w_{df} = 1.25 \times (5.28 + 1 + 1) = 9.10 \text{ kN/m}^2 \quad \text{CSA A23.3-14 (Annex C. Table C.1 a)}$$

$$\text{Factored live load} \rightarrow w_{lf} = 1.5 \times 3.6 = 5.40 \text{ kN/m}^2$$

$$\text{Total factored load} \rightarrow w_f = 9.10 + 5.40 = 14.50 \text{ kN/m}^2$$

Check the adequacy of slab thickness for beam action (one-way shear) from the edge of the interior drop panel.

CSA A23.3-14 (13.3.6)

Consider a 1 m wide strip. The critical section for one-way shear is located at a distance, d_v from the face of support (see Figure 7)

$$\text{Tributary area for one-way shear is } A_{Tributary} = \left(\frac{\left[\left(\frac{7500}{2} \right) - \left(\frac{2000}{2} \right) - 165 \right] \times (1000)}{1000^2} \right) = 2.59 \text{ m}^2$$

$$V_f = w_f \times A_{Tributary} = 14.50 \times 2.59 = 37.56 \text{ kN}$$

$$V_c = \phi_c \lambda \beta \sqrt{f'_c} b_w d_v$$

CSA A23.3-14 (Eq. 11.6)

Where $\lambda = 1$ for normal weight concrete

$$\beta = 0.21 \text{ for slabs with overall thickness not greater than 350 mm}$$

CSA A23.3-14 (11.3.6.2)

$$d_v = \text{Max} [0.9d, 0.75h]$$

CSA A23.3-14 (3.2)

$$d_v = \text{Max} [0.9(179), 0.75(220)] = \text{Max} [161.1, 165.0] = 165.0 \text{ mm}$$

$$\sqrt{f'_c} = 5 \text{ MPa} < 8 \text{ MPa}$$

CSA A23.3-14 (11.3.4)

$$V_c = 0.65 \times 1 \times 0.21 \times \sqrt{25} \times 1000 \times \frac{165}{1000} = 112.6 \text{ kN} > V_f$$

Slab thickness of 220 mm is adequate for one-way shear for the second critical section (from the edge of the drop panel).

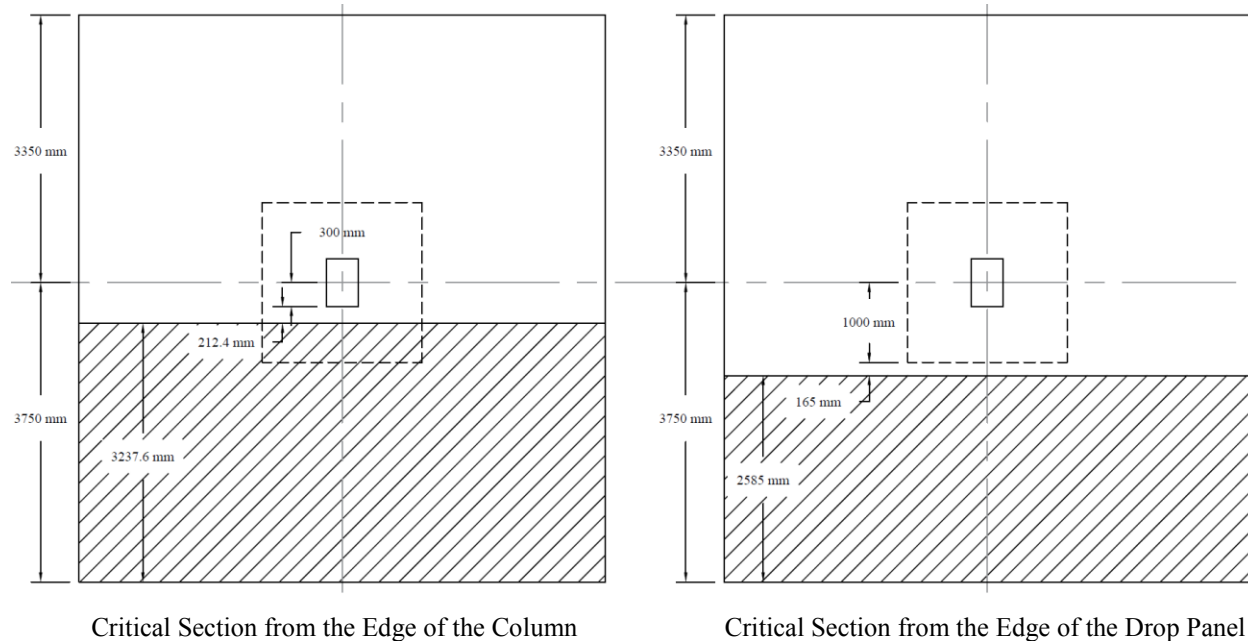

Figure 7 – Critical Sections for One-Way Shear

c. Slab shear strength – two-way shear

For critical section at distance $d/2$ from the edge of the column (slab section with drop panel):

Check the adequacy of slab thickness for punching shear (two-way shear) at an interior column (Figure 8):

$$\begin{aligned} \text{Tributary area for two-way shear is } A_{\text{Tributary}} &= (7.5/2 + 6.7/2) \times (6.6) - (0.6 + 0.236) \times (0.4 + 0.236) \\ &= 46.33 \text{ m}^2 \end{aligned}$$

$$V_f = w_f \times A_{\text{Tributary}} = 16.21 \times 46.33 = 751 \text{ kN}$$

$$b_o = 2 \times (600 + 236) + 2 \times (400 + 236) = 2944 \text{ mm}$$

CSA A23.3-14 (13.3.3)

$$v_f = \frac{V_f}{b_o d} = \frac{751 \times 1000}{2944 \times 236} = 1.08 \text{ MPa}$$

The factored resisting shear stress, v_r shall be the smallest of :

CSA A23.3-14 (13.3.4.1)

$$\text{a) } v_r = v_c = \left(1 + \frac{2}{\beta_c}\right) 0.19 \lambda \phi_c \sqrt{f'_c}$$

CSA A23.3-14 (Eq. 13.5)

$$v_r = \left(1 + \frac{2}{1.5}\right) \times 0.19 \times 0.65 \times \sqrt{25} = 1.44 \text{ MPa}$$

Where $\beta_c = \frac{600}{400} = 1.5$ (ratio of long side to short side of the column) CSA A23.3-14 (13.3.4.1)

b) $v_r = v_c = \left(\frac{\alpha_s d}{b_o} + 0.19 \right) \lambda \phi_c \sqrt{f'_c}$ CSA A23.3-14 (Eq. 13.6)

$$v_r = \left(\frac{4 \times 236}{2944} + 0.19 \right) \times 1 \times 0.65 \times \sqrt{25} = 1.66 \text{ MPa}$$

c) $v_r = v_c = 0.38 \lambda \phi_c \sqrt{f'_c} = 0.38 \times 1 \times 0.65 \times \sqrt{25} = 1.24 \text{ MPa}$ CSA A23.3-14 (Eq. 13.7)

$$\frac{v_r}{v_{f,ave}} = \frac{1.24}{1.08} = 1.15 < 1.20 \text{ (slightly less than 1.20)} \quad \text{CAC Concrete Design Handbook 4th Edition (5.2.3)}$$

Note that the ratio is less than 1.20. However, this is a preliminary check, the section is safe when performing the detailed calculations for punching shear check as shown later in this example.

Slab thickness of 220 mm is adequate for two-way shear for the first critical section (from the edge of the column).

For critical section at the edge of the drop panel (slab section without drop panel):

Check the adequacy of slab thickness for punching shear (two-way shear) at an interior drop panel (Figure 8):

$$\text{Tributary area for two-way shear is } A_{Tributary} = (7.5/2 + 6.7/2) \times (6.6) - (2.0 + 0.179)^2 = 42.11 \text{ m}^2$$

$$V_f = w_f \times A_{Tributary} = 14.50 \times 42.11 = 610.6 \text{ kN}$$

$$b_o = 4 \times (2000 + 179) = 8716 \text{ mm} \quad \text{CSA A23.3-14 (13.3.3)}$$

$$v_f = \frac{V_f}{b_o d} = \frac{610.6 \times 1000}{8716 \times 179} = 0.39 \text{ MPa}$$

The factored resisting shear stress, v_r shall be the smallest of: CSA A23.3-14 (13.3.4.1)

d) $v_r = v_c = \left(1 + \frac{2}{\beta_c} \right) 0.19 \lambda \phi_c \sqrt{f'_c}$ CSA A23.3-14 (Eq. 13.5)

$$v_r = \left(1 + \frac{2}{1.5} \right) \times 0.19 \times 0.65 \times \sqrt{25} = 1.44 \text{ MPa}$$

Where $\beta_c = \frac{600}{400} = 1.5$ (ratio of long side to short side of the column) CSA A23.3-14 (13.3.4.1)

e) $v_r = v_c = \left(\frac{\alpha_s d}{b_o} + 0.19 \right) \lambda \phi_c \sqrt{f'_c}$ CSA A23.3-14 (Eq. 13.6)

$$v_r = \left(\frac{4 \times 179}{8716} + 0.19 \right) \times 1 \times 0.65 \times \sqrt{25} = 0.88 \text{ MPa}$$

$$f) \quad v_r = v_c = 0.38\lambda\phi_c\sqrt{f'_c} = 0.38 \times 1 \times 0.65 \times \sqrt{25} = 1.24 \text{ MPa}$$

CSA A23.3-14 (Eq. 13.7)

$$\frac{v_r}{v_{f,ave}} = \frac{0.88}{0.39} = 2.26 > 1.20$$

CAC Concrete Design Handbook 4th Edition (5.2.3)

Slab thickness of 220 mm is adequate for two-way shear for the second critical section (from the edge of the drop panel).

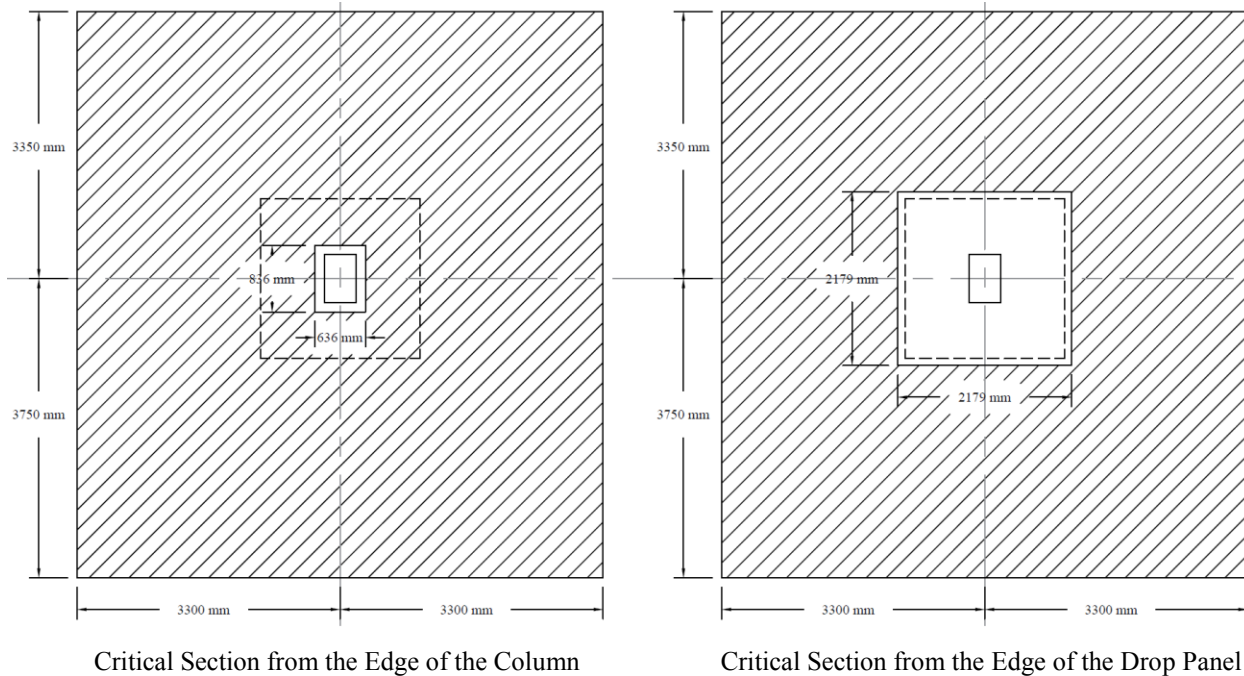

Figure 8 – Critical Sections for Two-Way Shear

d. Column dimensions - axial load

Check the adequacy of column dimensions for axial load:

Tributary area for interior column for live load, superimposed dead load, and self-weight of the slab is

$$A_{Tributary} = 7.5 \times 6.7 = 50.25 \text{ m}^2$$

Tributary area for interior column for self-weight of additional slab thickness due to the presence of the drop panel is

$$A_{Tributary} = 2 \times 2 = 4 \text{ m}^2$$

Assuming five story building

$$P_f = n \times w_f \times A_{Tributary} = 5 \times (14.50 \times 50.25 + (16.21 - 14.50) \times 4) = 3677 \text{ kN}$$

Assume 600 mm x 400 mm column with 12 – 30M vertical bars with design axial strength, $P_{r,max}$ of

$$P_{r,max} = (0.2 + 0.002h)P_{ro} \leq 0.80P_{ro} \quad \text{(For tied column along full length)} \quad \underline{\underline{CSA A23.3-14 (Eq. 10.9)}}$$

$$P_{ro} = \alpha_1 \phi_c f'_c (A_g - A_{st} - A_t - A_p) + \phi_s f_y A_{st} + \phi_a F_y A_t - f_{pr} A_p \quad \underline{\underline{CSA A23.3-14 (Eq. 10.11)}}$$

$$P_{ro} = 0.81 \times 0.65 \times 25 \times (600 \times 400 - 12 \times 700) + 0.85 \times 400 \times (12 \times 700) + 0 = 5904 \text{ kN}$$

$$P_{r,max} = (0.2 + 0.002 \times 600) \times 5904 \leq 0.80 \times 5904$$

$$= 8266 \leq 4723$$

$$= 4723 \text{ kN} < P_f = 3677 \text{ kN}$$

Where:

$$\alpha_1 = 0.85 - 0.0015f'_c = 0.85 - 0.0015 \times 25 = 0.81 > 0.67 \quad \underline{\underline{CSA A23.3-14 (Eq. 10.1)}}$$

Column dimensions of 600 mm x 400 mm are adequate for axial load.

2. Flexural Analysis and Design

CSA A23.3 states that a regular slab system may be designed using any procedure satisfying conditions of equilibrium and compatibility with the supports, provided that it is shown that the factored resistance at every section is at least equal to the effects of the factored loads and that all serviceability conditions, including specified limits on deflections, are met. CSA A23.3-14 (13.5.1)

CSA A23.3 permits the use of Plastic Plate Theory Method (PPTM), Theorems of Plasticity Method (TPM), Direct Design Method (DDM) and Elastic Frame Method (EFM); known as Equivalent Frame Method in the ACI; for the gravity load analysis of orthogonal frames. The following sections outline a brief description of DDM, a detailed hand solution using EFM and an automated solution using spSlab software respectively.

2.1. Direct Design Method (DDM)

Two-way slabs satisfying the limits in CSA A23.3-14 (13.9) are permitted to be designed in accordance with the DDM.

2.1.1. Direct design method limitations

There shall be a minimum of three continuous spans in each direction (3 spans) CSA A23.3-14 (13.9.1.2)

Successive span lengths centre-to-centre of supports in each direction shall not differ by more than one-third of the longer span ($(7500-6700)/6700 = 0.12 < 0.33$) CSA A23.3-14 (13.9.1.3)

All loads shall be due to gravity only and uniformly distributed over an entire panel (Loads are uniformly distributed over the entire panel) CSA A23.3-14 (13.9.1.4)

The factored live load shall not exceed twice the factored dead load (Service live-to-dead load ratio of (0.47 and $0.57 < 2.0$) CSA A23.3-14 (13.9.1.4)

Since all the criteria are met, Direct Design Method can be utilized.

This example focus on the analysis of slabs with drop panels using EFM. Detailed illustration of the analysis using DDM can be found in “[Two-Way Flat Plate Concrete Slab Floor Analysis and Design \(CSA A23.3-14\)](#)” example available in the [design examples](#) page in [StructurePoint](#) website.

2.2. Elastic Frame Method (EFM)

EFM (as known as Equivalent Frame Method in the ACI 318) is the most comprehensive and detailed procedure provided by the CSA A23.3 for the analysis and design of two-way slab systems where these systems may, for purposes of analysis, be considered a series of plane frames acting longitudinally and transversely through the building. Each frame shall be composed of equivalent line members intersecting at member centerlines, shall follow a column line, and shall include the portion of slab bounded laterally by the centerline of the panel on each side. *CSA A23.3-14 (13.8.1.1)*

Probably the most frequently used method to determine design moments in regular two-way slab systems is to consider the slab as a series of two-dimensional frames that are analyzed elastically. When using this analogy, it is essential that stiffness properties of the elements of the frame be selected to properly represent the behavior of the three-dimensional slab system.

In a typical frame analysis it is assumed that at a beam-column connection all members meeting at the joint undergo the same rotation. For uniform gravity loading this reduced restraint is accounted for by reducing the effective stiffness of the column by either Clause 13.8.2 or Clause 13.8.3. *CSA A23.3-14 (N.13.8)*

Each floor and roof slab with attached columns may be analyzed separately, with the far ends of the columns considered fixed. *CSA A23.3-14 (13.8.1.2)*

The moment of inertia of column and slab-beam elements at any cross-section outside of joints or column capitals shall be based on the gross area of concrete at that section. *CSA A23.3-14 (13.8.2.5)*

An equivalent column shall be assumed to consist of the actual columns above and below the slab-beam plus an attached torsional member transverse to the direction of the span for which moments are being determined. *CSA A23.3-14 (13.8.2.5)*

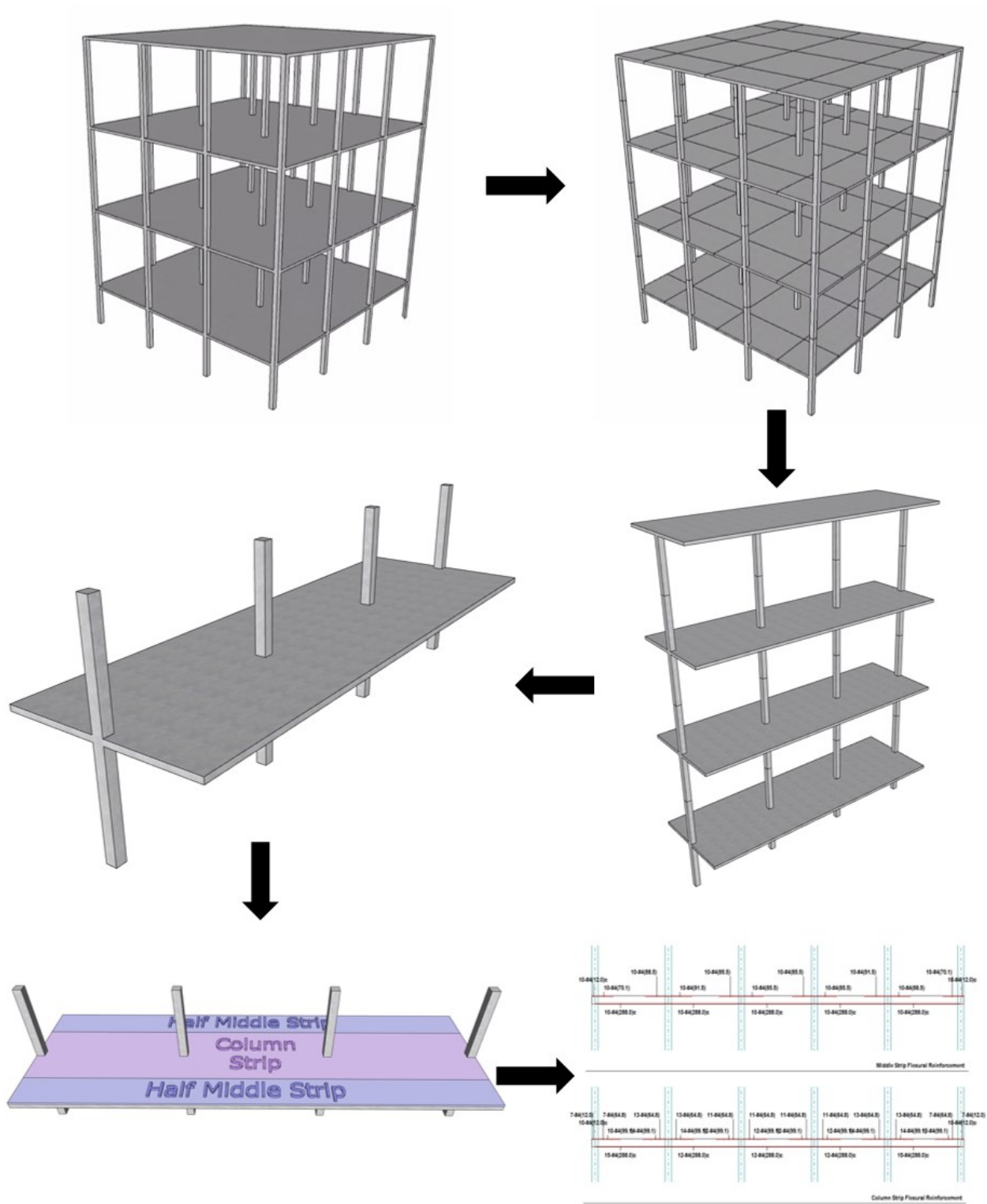

Figure 9 – Equivalent Frame Methodology

2.2.1. Limitations for use of elastic frame method

In EFM, live load shall be arranged in accordance with 13.8.4 which requires:

- Slab systems to be analyzed and designed for the most demanding set of forces established by investigating the effects of live load placed in various critical patterns. CSA A23.3-14 (13.8.4)
- Complete analysis must include representative interior and exterior equivalent elastic frames in both the longitudinal and transverse directions of the floor. CSA A23.3-14 (13.8.1.1)
- Panels shall be rectangular, with a ratio of longer to shorter panel dimensions, measured center-to-center of supports, not to exceed 2. CSA A23.3-14 (13.2.2)
- For slab systems with beams between supports, the relative effective stiffness of beams in the two directions is not less than 0.2 or greater than 2. CSA A23.3-14 (13.2.2)
- Column offsets are not greater than 20% of the span (in the direction of offset) from either axis between centerlines of successive columns. CSA A23.3-14 (13.2.2)
- The reinforcement is placed in an orthogonal grid. CSA A23.3-14 (13.2.2)

2.2.2. Frame members of elastic frame

Determine moment distribution factors and fixed-end moments for the equivalent frame members. The moment distribution procedure will be used to analyze the elastic (equivalent) frame. Stiffness factors k , carry over factors COF, and fixed-end moment factors FEM for the slab-beams and column members are determined using the design aids tables at Appendix 20A of PCA Notes on ACI 318-11. These calculations are shown below.

- a. Flexural stiffness of slab-beams at both ends, K_{sb} .

For Interior Span:

$$\frac{c_{N1}}{\ell} = 0.080, \quad \frac{c_{N2}}{\ell} = 0.061$$

For $c_{F1} = c_{N2}$, stiffness factors, $k_{NF} = k_{FN} = 4.89$

PCA Notes on ACI 318-11 (Table A2)

$$\text{Thus, } K_{sb} = k_{NF} \frac{E_{cs} I_s}{\ell}$$

PCA Notes on ACI 318-11 (Table A2)

$$K_{sb} = 4.89 \times 24,986 \times \frac{5.86 \times 10^9}{7500} \times 10^{-3} = 95.5 \times 10^6 \text{ N.m}$$

$$\text{where, } I_s = \frac{\ell^3}{12} = \frac{00(220)^3}{12} = 5.86 \times 10^9 \text{ mm}^4$$

$$E_{cs} = (3300\sqrt{f'_c} + 6900) \left(\frac{\gamma_c}{2300} \right)^{1.5} \quad \text{CSA A23.3-14(8.6.2.2)}$$

$$E_{cs} = (3300\sqrt{25} + 6900) \left(\frac{2402.8}{2300} \right)^{1.5} = 24,986 \text{ MPa}$$

Carry-over factor COF = 0.54

PCA Notes on ACI 318-11 (Table A2)

$$\text{Fixed-end moment, } FEM = \sum_{i=1}^n m_{NFi} \times w_i \times l_i^2$$

PCA Notes on ACI 318-11 (Table A2)

Uniform load fixed end moment coefficient, $m_{NFI} = 0.0884$

Fixed end moment coefficient for (b-a) = 0.2 when a = 0, $m_{NF2} = 0.0158$

Fixed end moment coefficient for (b-a) = 0.2 when a = 0.8, $m_{NF3} = 0.0021$

For Exterior Span:

$$\frac{c_{N1}}{\ell} = 0.090, \quad \frac{c_{N2}}{\ell} = 0.061$$

For $c_{F1} = c_{N2}$, stiffness factors, $k_{NF} = k_{FN} = 4.90$

PCA Notes on ACI 318-11 (Table A2)

$$\text{Thus, } K_{sb} = k_{NF} \frac{E_{cs} I_s}{\ell} = 4.90 \frac{E_{cs} I_s}{\ell}$$

PCA Notes on ACI 318-11 (Table A2)

$$K_{sb} = 4.90 \times 24,986 \times \frac{5.86 \times 10^9}{6700} \times 10^{-3} = 107.1 \times 10^6 \text{ N.m}$$

$$\text{where, } I_s = \frac{\ell^3}{12} = \frac{00(220)^3}{12} = 5.86 \times 10^9 \text{ mm}^4$$

$$E_{cs} = (3300\sqrt{f'_c} + 6900) \left(\frac{\gamma_c}{2300} \right)^{1.5}$$

CSA A23.3-14(8.6.2.2)

$$E_{cs} = (3300\sqrt{25} + 6900) \left(\frac{2402.8}{2300} \right)^{1.5} = 24,986 \text{ MPa}$$

Carry-over factor COF = 0.55

PCA Notes on ACI 318-11 (Table A2)

$$\text{Fixed-end moment, } FEM = \sum_{i=1}^n m_{NFi} \times w_i \times l_i^2$$

PCA Notes on ACI 318-11 (Table A2)

Uniform load fixed end moment coefficient, $m_{NFI} = 0.0885$

Fixed end moment coefficient for (b-a) = 0.2 when a = 0, $m_{NF2} = 0.0159$

Fixed end moment coefficient for (b-a) = 0.2 when a = 0.8, $m_{NF3} = 0.0021$

b. Flexural stiffness of column members at both ends, K_c .

Referring to **Table A7, Appendix 20A**,

For the Bottom Column (Below):

$$t_a = 220 / 2 + 57 = 167 \text{ mm}, t_b = 220 / 2 = 110 \text{ mm}$$

$$\frac{t_a}{t_b} = \frac{167}{110} = 1.52$$

$$H = 3 \text{ m} = 3000 \text{ mm}, H_c = 3000 \text{ mm} - 167 \text{ mm} - 57 \text{ mm} = 2723 \text{ mm}$$

$$\frac{H}{H_c} = \frac{3000}{2723} = 1.102$$

Thus, $k_{AB} = 5.26$ and $C_{AB} = 0.55$ by interpolation.

$$K_{c, \text{bottom}} = \frac{5.26 E_{cc} I_c}{\ell}$$

PCA Notes on ACI 318-11 (Table A7)

$$K_c = 5.26 \times 24,986 \times \frac{7.20 \times 10^9}{3000 \times 1000} = 315.4 \times 10^6 \text{ N.m}$$

$$\text{Where } I_c = \frac{b \times h^3}{12} = \frac{400(600)^3}{12} = 7.20 \times 10^9 \text{ mm}^4$$

$$E_{cc} = (3300 \sqrt{f'_c} + 6900) \left(\frac{\gamma_c}{2300} \right)^{1.5}$$

CSA A23.3-14(8.6.2.2)

$$E_{cc} = (3300 \sqrt{25} + 6900) \left(\frac{2402.8}{2300} \right)^{1.5} = 24,986 \text{ MPa}$$

$$\ell \quad \text{m} = 3000 \text{ mm}$$

For the Top Column (Above):

$$\frac{t_b}{t_a} = \frac{110}{167} = 0.66$$

$$\frac{H}{H_c} = \frac{3000}{2723} = 1.102$$

Thus, $k_{BA} = 4.96$ and $C_{BA} = 0.59$ by interpolation.

$$K_c = \frac{4.96 E_{cc} I_c}{\ell}$$

PCA Notes on ACI 318-11 (Table A7)

$$K_{c, \text{top}} = 4.96 \times 24,986 \times \frac{7.20 \times 10^9}{3000 \times 1000} = 297.4 \times 10^6 \text{ N.m}$$

c. Torsional stiffness of torsional members, K_t .

$$K_t = \frac{9E_{cs}C}{\ell \sqrt{\ell}}$$

CSA A23.3-14(13.8.2.8)

$$K_t = \frac{9 \times 24,986 \times 3.01 \times 10^9}{6600 \times \left(1 - \frac{600}{6600}\right)^3} \times 10^{-3} = 136.5 \times 10^6 \text{ N.m}$$

Where $C = \sum \left(1 - 0.63 \frac{x}{y}\right) \left(\frac{x^3 y}{3}\right)$

CSA A23.3-14(13.8.2.9)

$$C = \left(1 - 0.63 \times \frac{277}{600}\right) \left(\frac{277^3 \times 600}{3}\right) = 3.01 \times 10^9 \text{ mm}^4$$

$$c_2 = 400 \text{ mm}, \ell \quad \quad \quad \ell = 6600 \text{ mm}$$

Equivalent column stiffness K_{ec} .

$$K_{ec} = \frac{\sum K_c \times \sum K_t}{\sum K_c + \sum K_t}$$

$$K_{ec} = \frac{(315.4 + 297.4) \times (2 \times 136.5)}{(315.4 + 297.4) + (2 \times 136.5)} \times 10^6$$

$$K_{ec} = 188.9 \times 10^6 \text{ N.m}$$

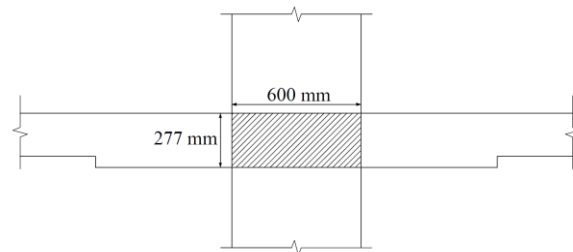

Figure 10 - Torsional Member

Where $\sum K_t$ is for two torsional members one on each side of the column, and $\sum K_c$ is for the upper and lower columns at the slab-beam joint of an intermediate floor.

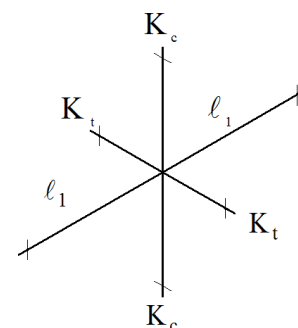

Figure 11 - Column and Edge of Slab

d. Slab-beam joint distribution factors, DF .

At exterior joint,

$$DF = \frac{107.1}{(107.1 + 188.9)} = 0.362$$

At interior joint,

$$DF_{Ext} = \frac{107.1}{(95.5 + 107.1 + 188.9)} = 0.274$$

$$DF_{Int} = \frac{95.5}{(95.5 + 107.1 + 188.9)} = 0.244$$

COF for slab-beam = 0.54 for Interior Span
= 0.55 for Exterior Span

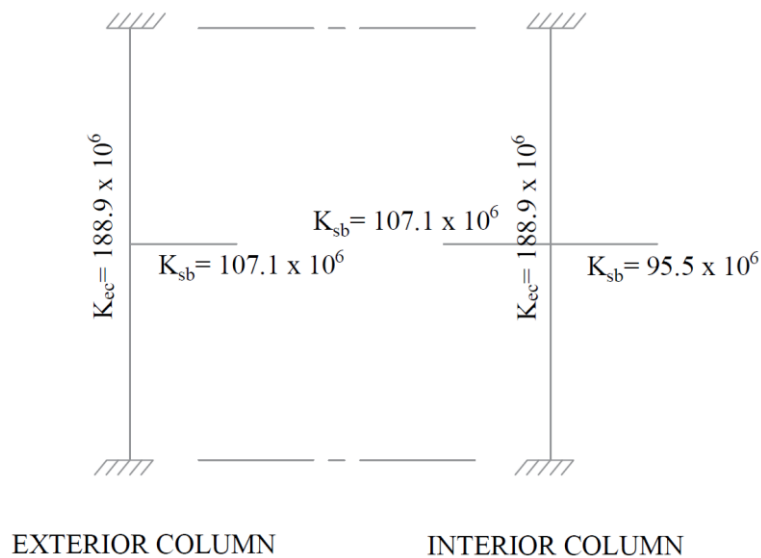

Figure 12 – Slab and Column Stiffness

2.2.3. Elastic frame analysis

Determine negative and positive moments for the slab-beams using the moment distribution method. Since the unfactored live load does not exceed three-quarters of the unfactored dead load, design moments are assumed to occur at all critical sections with full factored live on all spans. CSA A23.3-14 (13.8.4.2)

$$\frac{L}{D} = \frac{3.6}{5.28+1+1} = 0.49 < \frac{3}{4}$$

- a. Factored load and Fixed-End Moments (FEM's).

For slab:

Factored dead load $\rightarrow w_{df} = 1.25 \times (5.28 + 1 + 1) = 9.10 \text{ kN/m}^2$ CSA A23.3-14 (Annex C. Table C.1 a)

Factored live load $\rightarrow w_{lf} = 1.5 \times 3.6 = 5.40 \text{ kN/m}^2$

Total factored load $\rightarrow w_f = 9.10 + 5.40 = 14.50 \text{ kN/m}^2$

For drop panels:

Factored dead load $w_{df} = 1.25 \times (24 \times 0.057) = 1.71 \text{ kN/m}^2$

Factored live load $w_{lf} = 1.5 \times 0 = 0 \text{ kN/m}^2$

Factored load $w_f = w_{df} + w_{lf} = 1.71 \text{ kN/m}^2$

Fixed-end moment, $FEM = \sum_{i=1}^n m_{NFi} \times w_i \times l_1^2$ PCA Notes on ACI 318-11 (Table A1)

For interior span

$$FEM = 0.0884 \times 14.50 \times 6.6 \times 7.5^2 + 0.0158 \times 1.71 \times 2 \times 7.5^2 + 0.0021 \times 1.71 \times 2 \times 7.5^2$$

$$FEM = 479.3 \text{ kN.m}$$

For exterior span

$$FEM = 0.0885 \times 14.50 \times 6.6 \times 6.7^2 + 0.0159 \times 1.71 \times 2 \times 6.7^2 + 0.0021 \times 1.71 \times 2 \times 6.7^2$$

$$FEM = 383.0 \text{ kN.m}$$

- b. Moment distribution. Computations are shown in Table 1. Counterclockwise rotational moments acting on the member ends are taken as positive. Positive span moments are determined from the following equation:

$$M_{f, \text{midspan}} = M_o - \frac{(M_{uL} + M_{uR})}{2}$$

Where M_o is the moment at the midspan for a simple beam.

When the end moments are not equal, the maximum moment in the span does not occur at the midspan, but its value is close to that midspan for this example.

Positive moment in span 1-2:

$$M_u = \frac{(14.50 \times 6.6) \times 6.7^2}{8} + \left[\frac{(1.71 \times 2 \times 6.7 / 6) \times 6.7 / 6}{2 \times 6.7} \times 6.7 / 6 \times (6.7 - 6.7 / 2) \right] - \frac{(242 + 465)}{2}$$

$$M_f = 184.6 \text{ kN.m}$$

						
Joint	1	2		3		4
Member	1-2	2-1	2-3	3-2	3-4	4-3
DF	0.362	0.274	0.244	0.244	0.274	0.362
COF	0.550	0.550	0.540	0.540	0.550	0.550
FEM	383	-383	479.3	-479.3	383	-383
Dist	-138.7	-26.4	-23.5	23.5	26.4	138.7
CO	-14.5	-76.3	12.7	-12.7	76.3	14.5
Dist	5.3	17.4	15.5	-15.5	-17.4	-5.3
CO	9.6	2.9	-8.4	8.4	-2.9	-9.6
Dist	-3.5	1.5	1.3	-1.3	-1.5	3.5
CO	0.8	-1.9	-0.7	0.7	1.9	-0.8
Dist	-0.3	0.7	0.6	-0.6	-0.7	0.3
CO	0.4	-0.2	-0.3	0.3	0.2	-0.4
Dist	-0.1	0.1	0.1	-0.1	-0.1	0.1
CO	0.1	-0.1	-0.1	0.1	0.1	-0.1
Dist	0.0	0.0	0.0	0.0	0.0	0.0
M, kN.m	242.0	-465.1	476.6	-476.6	465.1	-242.0
Midspan M, kN.m	184.6		198.0		184.6	

2.2.4. Factored moments used for Design

Positive and negative factored moments for the slab system in the direction of analysis are plotted in Figure 12. The negative moments used for design are taken at the faces of supports (rectangle section or equivalent rectangle for circular or polygon sections) but not at distances greater than $0.175 l_1$ from the centers of supports. **CSA A23.3-14 (13.8.5.1)**

$$\frac{600}{2} = 300 \text{ mm} < 0.175 \times 6700 = 1172.5 \text{ mm (use face of supporting location)}$$

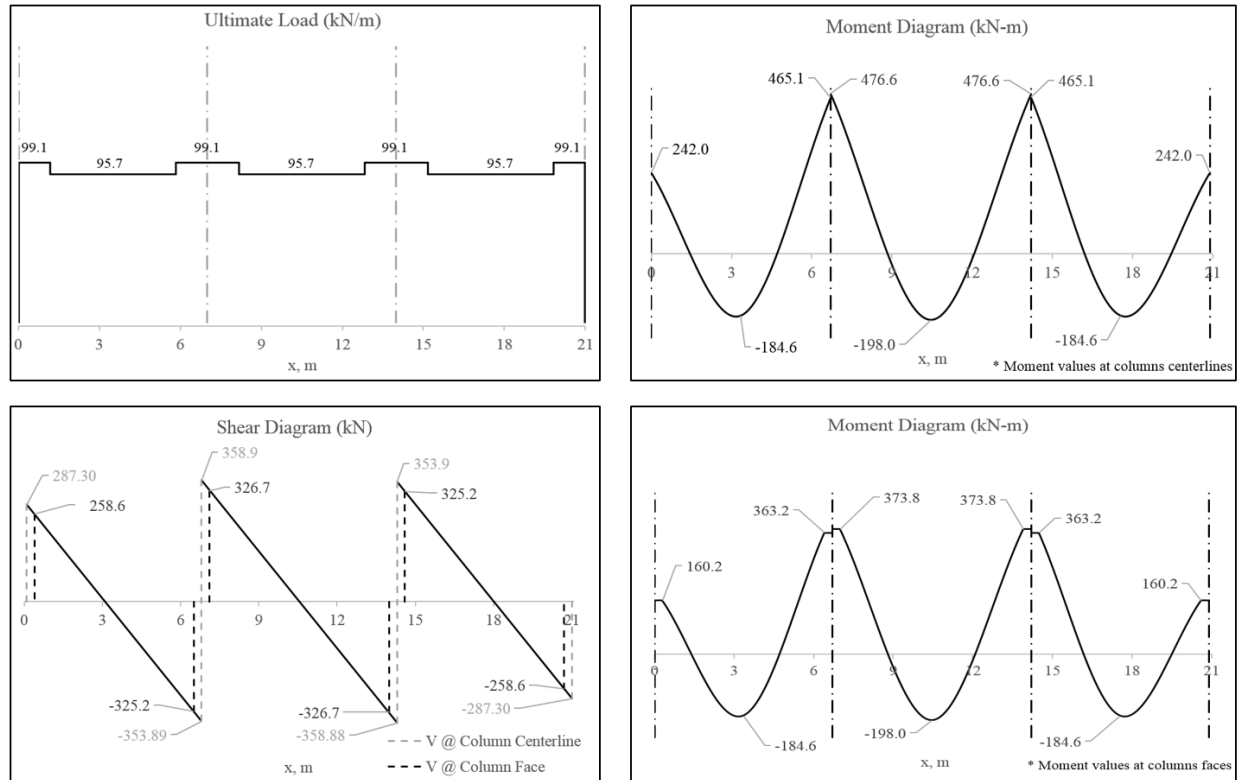

Figure 12 - Positive and Negative Design Moments for Slab-Beam (All Spans Loaded with Full Factored Live Load)

2.2.5. Distribution of design moments

Check Applicability of Direct Design Method:

- | | |
|--|---------------------------------------|
| 1. There is a minimum of three continuous spans in each direction. | <u>CSA A23.3-14 (13.9.1.2)</u> |
| 2. Successive span lengths are equal. | <u>CSA A23.3-14 (13.9.1.3)</u> |
| 3. Loads are uniformly distributed over the entire panel | <u>CSA A23.3-14 (13.9.1.4)</u> |
| 4. Factored live-to-dead load ratio of $0.5 < 2.0$ | <u>CSA A23.3-14 (13.9.1.4)</u> |

(Note: The self-weight of the drop panels is not uniformly distributed entirely along the span. However, the variation in load magnitude is small).

After the negative and positive moments have been determined for the slab-beam strip, the CSA code permits the distribution of the moments at critical sections to the column strips, beams (if any), and middle strips in accordance with the DDM. **CSA A23.3-14 (13.11.2.3)**

Distribution of factored moments at critical sections is summarized in Table 2.

Table 2 - Distribution of factored moments

		Slab-beam Strip	Column Strip		Middle Strip	
		Moment (kN.m)	Percent	Moment (kN.m)	Percent	Moment (kN.m)
End Span	Exterior Negative	160.2	100	160.2	0	0.00
	Positive	184.6	60	110.8	40	73.8
	Interior Negative	363.2	82.5	299.6	17.5	63.6
Interior Span	Negative	373.8	82.5	308.4	17.5	65.4
	Positive	198.0	60	118.8	40	79.2

2.2.6. Flexural reinforcement requirements

- a. Determine flexural reinforcement required for strip moments

The flexural reinforcement calculation for the column strip of end span – exterior negative location is provided below.

Reinforcement for the total factored negative moment transferred to the exterior columns shall be placed within a band width b_b . Temperature and shrinkage reinforcement determined as specified in clause 7.8.1 shall be provided in that section of the slab outside of the band region defined by b_b or as required by clause 13.10.9. **CSA A23.3-14 (13.10.3)**

$$M_r = 160.2 \text{ kN.m}$$

$$\text{Use } d_l = 244 \text{ mm}$$

In this example, jd will be assumed to be taken equal to $0.969d$. The assumptions will be verified once the area of steel is finalized.

$$\text{Assume } jd = 0.968 \times d = 236.2 \text{ mm}$$

$$\text{Column strip width, } b = 6,600 / 2 = 3,300 \text{ mm}$$

$$\text{Middle strip width, } b = 6,600 - 3,300 = 3,300 \text{ mm}$$

$$A_s = \frac{M_r}{\phi_s f_y jd} = \frac{160.2}{0.85 \times 400 \times 0.968 \times 244} = 1995 \text{ mm}^2$$

$$\alpha_1 = 0.85 - 0.0015 f'_c = 0.81 > 0.67$$

CSA A23.3-14 (10.1.7)

$$\text{Recalculate 'a' for the actual } A_s = 1995 \text{ mm}^2 \rightarrow a = \frac{\phi_s A_s f_y}{\phi_c \alpha_1 f'_c b} = \frac{0.85 \times 1995 \times 400}{0.65 \times 0.81 \times 25 \times 3300} = 15.57 \text{ mm}$$

$$jd = d - \frac{a}{2} = 0.968d$$

Therefore, the assumption that jd equals to $0.968d$ is valid.

$$\therefore A_{s,req} = 1995 \text{ mm}^2$$

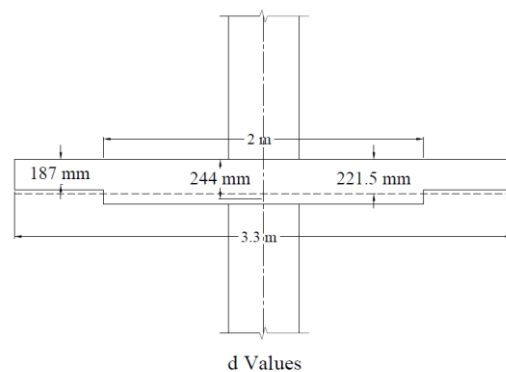

Reinforcement for the total factored negative moment transferred to the exterior columns shall be placed within a band width b_b . **CSA A23.3-14 (13.10.3)**

For the part of the slab inside of the band region:

$$b_b = c_2 + 2 \times (1.5 \times h_d) = 400 + 2 \times (1.5 \times 277) = 1231 \text{ mm}$$

Provide 10 - 15M bars ($2000 \text{ mm}^2 > 1995 \text{ mm}^2$)

Temperature and shrinkage reinforcement determined as specified in clause 7.8.1 shall be provided in that section of the slab outside of the band region defined by b_b or as required by clause 13.10.9 (including middle strip and the remaining part of the column strip outside the band region). **CSA A23.3-14 (13.10.3)**

For the remaining part of the column strip outside of the band region:

$$A_{s,\min} = 0.002 A_g = 0.002 \times 254.54 \times (3300 - 1231) = 1053 \text{ mm}^2 \quad \text{CSA A23.3-14 (7.8.1)}$$

Provide 6 - 15M bars ($1200 \text{ mm}^2 > 1053 \text{ mm}^2$)

The slab have two thicknesses in the column strip (277 mm for the slab with the drop panel and 220 mm for the slab without the drop panel).

The weighted slab thickness:

$$h_w = \frac{277 \times 2 + 220 \times (3.3 - 2)}{3.3} = 254.54 \text{ mm}$$

Total Reinforcement in the column Strip:

$$(10 - 15M) + (6 - 15M) = (16 - 15M)$$

For middle strip:

$$A_{s,\min} = 0.002 A_g = 0.002 \times 220 \times (3300) = 1452 \text{ mm}^2 \quad \text{CSA A23.3-14 (7.8.1)}$$

Provide 8 - 15M bars ($1600 \text{ mm}^2 > 1452 \text{ mm}^2$)

Maximum spacing:

CSA A23.3-14 (13.10.4)

- Negative reinforcement in the band defined by b_b : $1.5h_w = 382 \text{ mm} \leq 250 \text{ mm}$

$$s_{\max} = 250 \text{ mm} > s_{\text{provided}} = 1231/10 = 123 \text{ mm}$$

- Remaining negative moment reinforcement in column strip: $3h_w = 764 \text{ mm} \leq 500 \text{ mm}$

$$s_{\max} = 500 \text{ mm} > s_{\text{provided}} = (3300 - 1231)/6 = 345 \text{ mm}$$

- Negative moment reinforcement in middle strip: $3h_s = 660 \text{ mm} \leq 500 \text{ mm}$

$$s_{\max} = 500 \text{ mm} > s_{\text{provided}} = 3300/8 = 413 \text{ mm}$$

Based on the procedure outlined above, values for all span locations are given in Table 3.

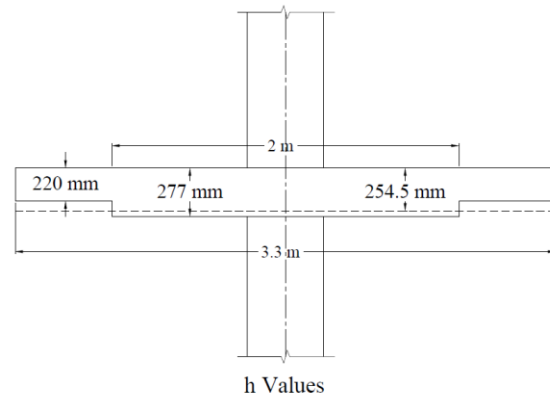

Table 3 - Required Slab Reinforcement for Flexure [Elastic Frame Method (EFM)]								
Span Location		M_r (kN.m)	b (m)	d (mm)	A_s Req'd for flexure (mm ²)	Min A_s (mm ²)	Reinforcement Provided	A_s Prov. for flexure (mm ²)
End Span								
Column Strip	Exterior Negative	160.2	3300	244	1995	1680	16 - 15M*	3200
	Positive	110.8	3300	187	1812	1452	10 - 15M	2000
	Interior Negative	299.6	3300	244	3850	1680	20 - 15M**	4000
Middle Strip	Exterior Negative	0.0	3300	187	0	1452	8 - 15M*	1600
	Positive	73.8	3300	187	1191	1452	8 - 15M	1600
	Interior Negative	63.6	3300	187	1022	1452	8 - 15M**	1600
Interior Span								
Column Strip	Negative	308.4	3300	244	3972	1680	20 - 15M**	4000
	Positive	118.8	3300	187	1948	1452	10 - 15M	2000
Middle Strip	Negative	65.4	3300	187	1052	1452	8 - 15M**	1600
	Positive	79.2	3300	187	1280	1452	8 - 15M	1600
* The reinforcement is selected to meet CSA A23.3-14 provision 13.10.3 as described previously.								
** The reinforcement is selected to meet CSA A23.3-14 provision 13.11.2.7 as described previously.								

- b. Calculate additional slab reinforcement at columns for moment transfer between slab and column by flexure

When gravity load, wind, earthquake, or other lateral forces cause transfer of moment between slab and column, a fraction of unbalanced moment given by γ_f shall be transferred by flexural reinforcement placed within a width b_b . CSA A23.3-14 (13.10.2)

Portion of the unbalanced moment transferred by flexure is $\gamma_f \times M_r$,

$$\gamma_f = \frac{1}{1 + (2/3) \times \sqrt{b_1 / b_2}} \quad \text{CSA A23.3-14 (13.10.2)}$$

Where

b_1 = Width of the critical section for shear measured in the direction of the span for which moments are determined according to CSA A23.3-14, clause 13 (see the following figure).

b_2 = Width of the critical section for shear measured in the direction perpendicular to b_1 according to CSA A23.3-14, clause 13 (see the following figure).

b_b = Effective slab width = $c_2 + 3 \times h_d$ CSA A23.3-14 (3.2)

$$b_b = 400 + 3 \times 277 = 1231 \text{ mm}$$

For Exterior Column

$$b_1 = 100 + 600 + \frac{244}{2} = 822 \text{ mm}$$

$$b_2 = 400 + 244 = 644 \text{ mm}$$

$$\gamma_f = \frac{1}{1 + (2/3) \times \sqrt{822/644}} = 0.570$$

For Interior Column

$$b_1 = 600 + 244 = 844 \text{ mm}$$

$$b_2 = 400 + 244 = 644 \text{ mm}$$

$$\gamma_f = \frac{1}{1 + (2/3) \times \sqrt{844/644}} = 0.567$$

Repeat the same procedure in section 2.2.6.a to calculate the additional reinforcement required for the unbalanced moment as shown in the following table:

Table 4 - Additional Slab Reinforcement required for moment transfer between slab and column (EFM)									
Span Location		M_u^* (kN.m)	γ_r	$\gamma_r M_u$ (kN.m)	Effective slab width, b_b (mm)	d (mm)	A_s req'd within b_b (mm ²)	A_s prov. For flexure within b_b (mm ²)	Add'l Reinf.
End Span									
Column Strip	Exterior Negative	242.0	0.570	137.9	1231	244	1766	2000	-
	Interior Negative	11.5	0.567	6.5	1231	244	44.5	1800	-

* M_u is taken at the centerline of the support in Elastic Frame Method solution.

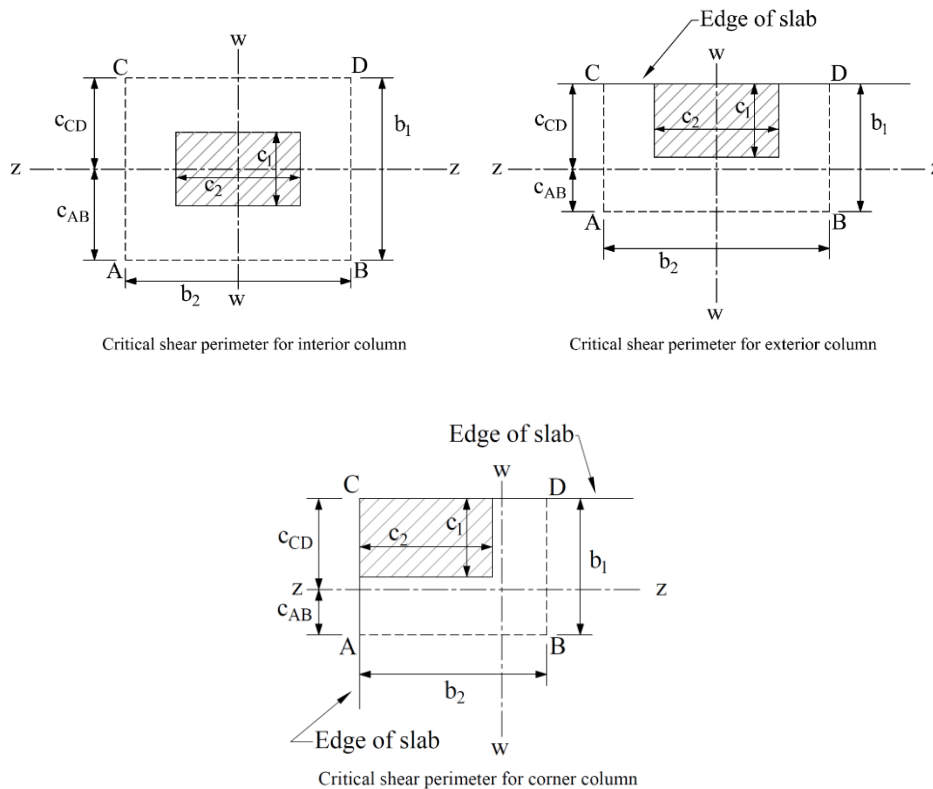

Figure 13 - Critical Shear Perimeters for Columns

2.2.7. Factored moments in columns

The unbalanced moment from the slab-beams at the supports of the equivalent frame are distributed to the support columns above and below the slab-beam in proportion to the relative stiffness of the support columns. Detailed calculations regarding this topic (including column design for axial load and biaxial moments) can be found in “[Two-Way Flat Slab \(Drop Panels\) Concrete Floor Analysis and Design \(CSA A23.3-14\)](#)” example available in the [design examples](#) page in [StructurePoint](#) website.

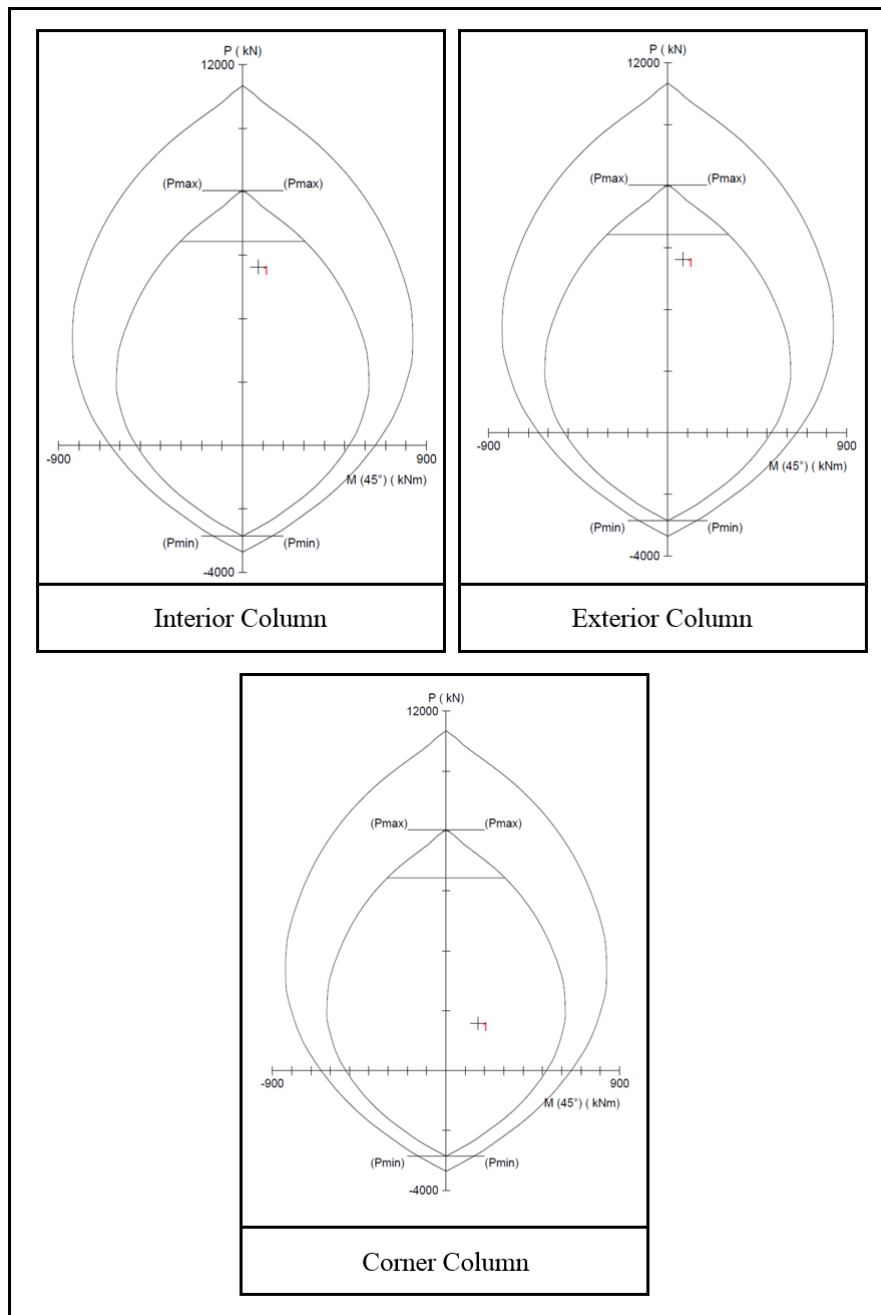

Figure 14 - Sample Calculations of Column Design from “Two-Way Flat Slab (Drop Panels) Concrete Floor Analysis and Design” Design Example

3. Shear Strength

Shear strength of the slab in the vicinity of columns/supports includes an evaluation of one-way shear (beam action) and two-way shear (punching) in accordance with CSA A23.3-14 Chapter 13.

3.1. One-Way (Beam action) Shear Strength

CSA A23.3-14 (13.3.6)

One-way shear is critical at a distance d_v from the face of the column as shown in Figure 3. Figures 15 and 16 show the factored shear forces (V_f) at the critical sections around each column and each drop panel, respectively. In members without shear reinforcement, the design shear capacity of the section equals to the design shear capacity of the concrete:

$$V_r = V_c + V_s + V_p = V_c \quad , \quad (V_s = V_p = 0) \quad \text{CSA A23.3-14 (Eq. 11.4)}$$

Where:

$$V_c = \phi_c \lambda \beta \sqrt{f'_c} b_w d_v \quad \text{CSA A23.3-14 (Eq. 11.5)}$$

Note: The calculations below follow one of two possible approaches for checking one-way shear. Refer to the conclusions section for a comparison with the other approach.

3.1.1. At distance d_v from the supporting column

$$h_{\text{weighted}} = \frac{277 \times 2 + 220 \times (6.6 - 2)}{6.6} = 237 \text{ mm}$$

$$d_w = 237 - 25 - 16 / 2 = 204 \text{ mm}$$

$$d_v = \text{Max} (0.9d, 0.72h) = \text{Max} (0.9 \times 204, 0.72 \times 237) = 184 \text{ mm} \quad \text{CSA A23.3-14 (3.2)}$$

$\lambda = 1$ for normal weight concrete

$$\beta = 0.21 \text{ for slabs with overall thickness not greater than 350 mm} \quad \text{CSA A23.3-14 (11.3.6.2)}$$

$$V_c = 0.65 \times 1 \times 0.21 \times \sqrt{25} \times 6600 \times \frac{184}{1000} = 828.8 \text{ kN} > V_f$$

Because $V_c \geq V_f$ at all the critical sections, the slab has adequate one-way shear strength.

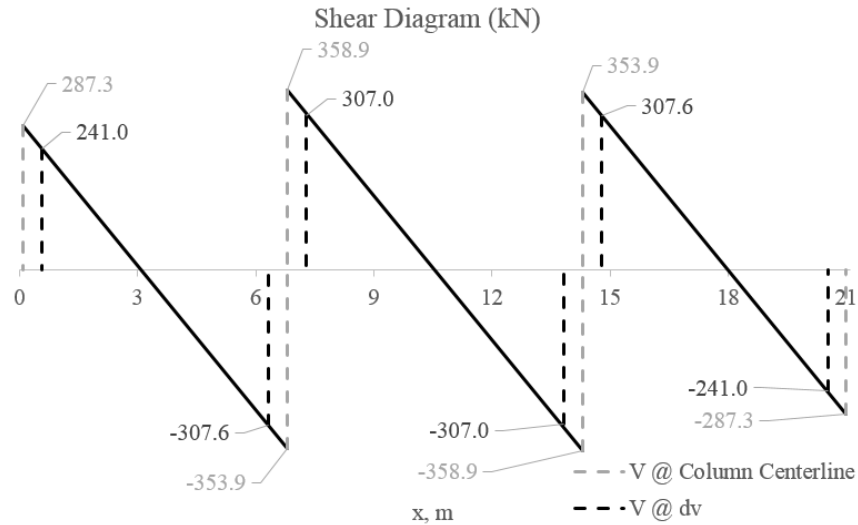

Figure 15 – One-way shear at critical sections (at distance d_v from the face of the supporting column)

3.1.2. At the face of the drop panel

$$h = 220 \text{ mm}$$

$$d = 220 - 25 - 16 / 2 = 187 \text{ mm}$$

$$d_v = \text{Max} (0.9d, 0.72h) = \text{Max} (0.9 \times 187, 0.72 \times 220) = 168 \text{ mm}$$

CSA A23.3-14 (3.2)

$$\lambda = 1 \text{ for normal weight concrete}$$

$$\beta = 0.21 \text{ for slabs with overall thickness not greater than 350 mm}$$

CSA A23.3-14 (11.3.6.2)

$$V_c = 0.65 \times 1 \times 0.21 \times \sqrt{25} \times 6600 \times \frac{168}{1000} = 756.8 \text{ kN} > V_f$$

Because $V_c \geq V_f$ at all the critical sections, the slab has adequate one-way shear strength.

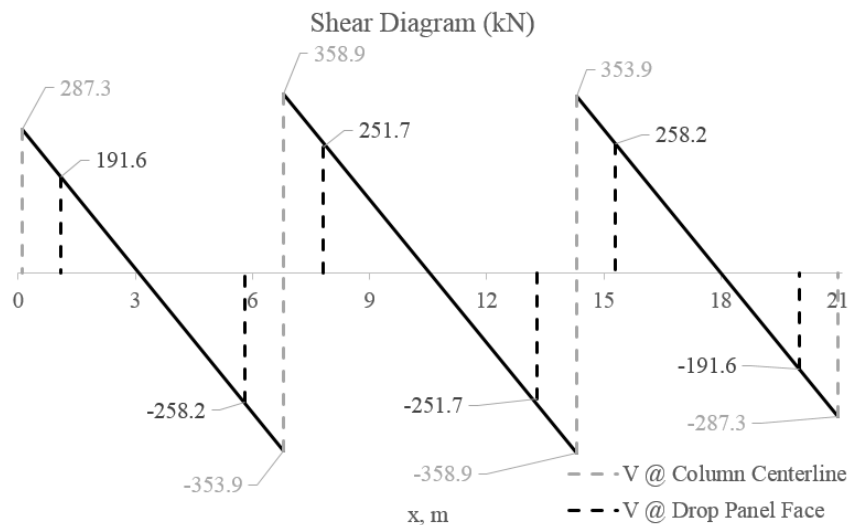

Figure 16 – One-way shear at critical sections (at the face of the drop panel)

3.2. Two-Way (Punching) Shear Strength

CSA A23.3-14 (13.3.2)

3.2.1. Around the columns faces

Two-way shear is critical on a rectangular section located at $d/2$ away from the face of the column as shown in Figure 13.

a. Exterior column:

The factored shear force (V_f) in the critical section is computed as the reaction at the centroid of the critical section minus the self-weight and any superimposed surface dead and live load acting within the critical section ($d/2$ away from column face).

$$V_f = V - w_f (b_1 \times b_2) = 287.3 - 16.21 \left(\frac{822 \times 644}{10^6} \right) = 278.7 \text{ kN}$$

The factored unbalanced moment used for shear transfer, M_{unb} , is computed as the sum of the joint moments to the left and right. Moment of the vertical reaction with respect to the centroid of the critical section is also taken into account.

$$M_{unb} = M - V_f (b_1 - c_{AB} - c_1 / 2) = 242 - 278.7 \left(\frac{822 - 295.3 - 600 / 2}{10^3} \right) = 206.7 \text{ kN.m}$$

For the exterior column in Figure 13, the location of the centroidal axis z-z is:

$$c_{AB} = \frac{\text{moment of area of the sides about AB}}{\text{area of the sides}} = \frac{2(822 \times 244 \times 822 / 2)}{2 \times 822 \times 244 + 644 \times 244} = 295.3 \text{ mm}$$

The polar moment J_c of the shear perimeter is:

$$J = 2 \left(\frac{b_1 d^3}{12} + \frac{d b_1^3}{12} + (b_1 d) \left(\frac{b_1}{2} - c_{AB} \right)^2 \right) + b_2 d c_{AB}^2$$

$$J = 2 \left(\frac{822 \times 244^3}{12} + \frac{244 \times 822^3}{12} + (822 \times 244) \left(\frac{822}{2} - 295.3 \right)^2 \right) + 644 \times 244 \times 295.3^2$$

$$J = 4.36 \times 10^{10} \text{ mm}^4$$

$$\gamma_v = 1 - \gamma_f = 1 - 0.570 = 0.430$$

CSA A23.3-14 (Eq. 13.8)

The length of the critical perimeter for the exterior column:

$$b_o = 2 \times 822 + 644 = 2288 \text{ mm}$$

The two-way shear stress (v_f) can then be calculated as:

$$v_f = \frac{V_f}{b_o \times d} + \frac{\gamma_v M_{umb} c_{AB}}{J}$$

CSA A23.3-14 (Eq.13.9)

$$v_f = \frac{278.7 \times 1000}{2288 \times 244} + \frac{0.430 \times (206.7 \times 10^6) \times 295.3}{4.36 \times 10^{10}}$$

$$v_f = 0.499 + 0.602 = 1.101 \text{ MPa}$$

It is worth noting that the 30% allowance from preliminary sizing appears not adequately anticipate the fraction of shear stress caused by unbalanced moment (120.6%) for two way shear check around the exterior column.

The factored resisting shear stress, V_r shall be the smallest of:

CSA A23.3-14 (13.3.4.1)

$$\text{a) } v_r = v_c = \left(1 + \frac{2}{\beta_c}\right) 0.19 \lambda \phi_c \sqrt{f'_c} = \left(1 + \frac{2}{600/400}\right) 0.19 \times 0.65 \times \sqrt{25} = 1.441 \text{ MPa}$$

$$\text{b) } v_r = v_c = \left(\frac{\alpha_s d}{b_o} + 0.19\right) \lambda \phi_c \sqrt{f'_c} = \left(\frac{3 \times 244}{2288} + 0.19\right) \times 1 \times 0.65 \times \sqrt{25} = 1.657 \text{ MPa}$$

$$\text{c) } v_r = v_c = 0.38 \lambda \phi_c \sqrt{f'_c} = 0.38 \times 1 \times 0.65 \times \sqrt{25} = 1.235 \text{ MPa}$$

$$v_r = v_c = 1.235 \text{ MPa}$$

Since $v_c \geq v_f$ at the critical section, the slab has adequate two-way shear strength around this column.

b. Interior column:

$$V_f = V - w_f (b_1 \times b_2) = 358.9 + 353.9 - 16.21 \left(\frac{844 \times 644}{10^6}\right) = 704.0 \text{ kN}$$

$$M_{umb} = M - V_f (b_1 - c_{AB} - c_1 / 2) = 476.6 - 465.1 - 704(0) = 11.5 \text{ kN}$$

For the interior column in Figure 13, the location of the centroidal axis z-z is:

$$c_{AB} = \frac{b_1}{2} = \frac{844}{2} = 422 \text{ mm}$$

The polar moment J_c of the shear perimeter is:

$$J = 2 \left(\frac{b_1 d^3}{12} + \frac{d b_1^3}{12} + (b_1 d) \left(\frac{b_1}{2} - c_{AB} \right)^2 \right) + 2 b_2 d c_{AB}^2$$

$$J = 2 \left(\frac{844 \times 244^3}{12} + \frac{244 \times 844^3}{12} + (844 \times 244) \left(\frac{844}{2} - 422 \right)^2 \right) + 2 \times 644 \times 244 \times 422^2$$

$$J = 8.25 \times 10^{10} \text{ mm}^4$$

$$\gamma_v = 1 - \gamma_f = 1 - 0.567 = 0.433$$

CSA A23.3-14 (Eq. 13.8)

The length of the critical perimeter for the interior column:

$$b_o = 2 \times (844 + 644) = 2976 \text{ mm}$$

The two-way shear stress (v_f) can then be calculated as:

$$v_f = \frac{V_f}{b_o \times d} + \frac{\gamma_v M_{unb} c_{AB}}{J}$$

CSA A23.3-14 (Eq. 13.9)

$$v_f = \frac{704.0 \times 1000}{2976 \times 244} + \frac{0.433 \times (11.5 \times 10^6) \times 422}{8.25 \times 10^{10}}$$

$$v_f = 0.970 + 0.025 = 0.995 \text{ MPa}$$

It is worth noting that the 20% allowance from preliminary sizing appears not adequately anticipate the fraction of shear stress caused by unbalanced moment (2.6%) for two way shear check around the interior column.

The factored resisting shear stress, V_r shall be the smallest of:

CSA A23.3-14 (13.3.4.1)

$$a) \quad v_r = v_c = \left(1 + \frac{2}{\beta_c}\right) 0.19 \lambda \phi_c \sqrt{f'_c} = \left(1 + \frac{2}{600/400}\right) 0.19 \times 0.65 \times \sqrt{25} = 1.441 \text{ MPa}$$

$$b) \quad v_r = v_c = \left(\frac{\alpha_s d}{b_o} + 0.19\right) \lambda \phi_c \sqrt{f'_c} = \left(\frac{4 \times 244}{2288} + 0.19\right) \times 1 \times 0.65 \times \sqrt{25} = 1.683 \text{ MPa}$$

$$c) \quad v_r = v_c = 0.38 \lambda \phi_c \sqrt{f'_c} = 0.38 \times 1 \times 0.65 \times \sqrt{25} = 1.235 \text{ MPa}$$

$$v_r = v_c = 1.235 \text{ MPa}$$

Since $v_c \geq v_f$ at the critical section, the slab has adequate two-way shear strength around this column.

c. Corner column:

In this example, interior equivalent elastic frame strip was selected where it only have exterior and interior supports (no corner supports are included in this strip). Detailed calculations for two-way (punching) shear check around corner supports can be found in “[Two-Way Flat Slab \(Drop Panels\) Concrete Floor Analysis and Design \(CSA A23.3-14\)](#)” example available in the [design examples](#) page in [StructurePoint](#) website.

3.2.2. Around drop panels

Two-way shear is critical on a rectangular section located at $d/2$ away from the face of the drop panel.

a. Exterior drop panel:

$$V_f = V - w_f (b_1 \times b_2) = 287.3 - 16.21 \left(\frac{1493.5 \times 2187}{10^6} \right) = 234.4 \text{ kN}$$

$$M_{umb} = M - V_f (b_1 - c_{AB} - c_1 / 2) = 242 - 234.4 \left(\frac{1493.5 - 431.1 - 600 / 2}{10^3} \right) = 86.8 \text{ kN.m}$$

$$c_{AB} = \frac{\text{moment of area of the sides about AB}}{\text{area of the sides}} = \frac{2(1493.5 \times 187 \times 1493.5 / 2)}{2 \times 1493.5 \times 187 + 2187 \times 187} = 431.1 \text{ mm}$$

The polar moment J_c of the shear perimeter is:

$$J = 2 \left(\frac{b_1 d^3}{12} + \frac{d b_1^3}{12} + (b_1 d) \left(\frac{b_1}{2} - c_{AB} \right)^2 \right) + b_2 d c_{AB}^2$$

$$J = 2 \left(\frac{1493.5 \times 187^3}{12} + \frac{187 \times 1493.5^3}{12} + (1493.5 \times 187) \left(\frac{1493.5}{2} - 431.1 \right)^2 \right) + 2187 \times 187 \times 431.1^2$$

$$J = 23.71 \times 10^{10} \text{ mm}^4$$

$$\gamma_f = \frac{1}{1 + (2/3) \times \sqrt{1493.5 / 2187}} = 0.645$$

$$\gamma_v = 1 - \gamma_f = 1 - 0.645 = 0.355$$

CSA A23.3-14 (Eq. 13.8)

The length of the critical perimeter for the exterior column:

$$b_o = 2 \times 1493.5 + 2187 = 5174 \text{ mm}$$

The two-way shear stress (v_f) can then be calculated as:

$$v_f = \frac{V_f}{b_o \times d} + \frac{\gamma_v M_{umb} c_{AB}}{J}$$

CSA A23.3-14 (Eq. 13.9)

$$v_f = \frac{234.4 \times 1000}{5174 \times 187} + \frac{0.355 \times (86.8 \times 10^6) \times 431.1}{23.71 \times 10^{10}}$$

$$v_f = 0.242 + 0.056 = 0.298 \text{ MPa}$$

It is worth noting that the 30% allowance from preliminary sizing appears adequately anticipate the fraction of shear stress caused by unbalanced moment (23.1%) for two way shear check around the exterior drop panel.

The factored resisting shear stress, V_r shall be the smallest of:

CSA A23.3-14 (13.3.4.1)

$$a) \quad v_r = v_c = \left(1 + \frac{2}{\beta_c}\right) 0.19 \lambda \phi_c \sqrt{f'_c} = \left(1 + \frac{2}{600/400}\right) 0.19 \times 0.65 \times \sqrt{25} = 1.441 \text{ MPa}$$

$$b) \quad v_r = v_c = \left(\frac{\alpha_s d}{b_o} + 0.19\right) \lambda \phi_c \sqrt{f'_c} = \left(\frac{3 \times 187}{5174} + 0.19\right) \times 1 \times 0.65 \times \sqrt{25} = 0.970 \text{ MPa}$$

$$c) \quad v_r = v_c = 0.38 \lambda \phi_c \sqrt{f'_c} = 0.38 \times 1 \times 0.65 \times \sqrt{25} = 1.235 \text{ MPa}$$

$$v_r = v_c = 0.970 \text{ MPa}$$

Since $v_c \geq v_f$ at the critical section, the slab has adequate two-way shear strength around this drop panel.

b. Interior drop panel:

$$V_f = V - w_f (b_1 \times b_2) = 358.9 + 353.9 - 16.21 \left(\frac{2187 \times 2187}{10^6}\right) = 635.3 \text{ kN}$$

$$M_{umb} = M - V_f (b_1 - c_{AB} - c_1 / 2) = 476.6 - 465.1 - 704(0) = 11.5 \text{ kN}$$

For the interior column in Figure 13, the location of the centroidal axis z-z is:

$$c_{AB} = \frac{b_1}{2} = \frac{2187}{2} = 1093.5 \text{ mm}$$

The polar moment J_c of the shear perimeter is:

$$J = 2 \left(\frac{b_1 d^3}{12} + \frac{d b_1^3}{12} + (b_1 d) \left(\frac{b_1}{2} - c_{AB} \right)^2 \right) + 2 b_2 d c_{AB}^2$$

$$J = 2 \left(\frac{2187 \times 187^3}{12} + \frac{187 \times 2187^3}{12} + (2187 \times 187) \left(\frac{2187}{2} - 1093.5 \right)^2 \right) + 2 \times 2187 \times 187 \times 1093.5^2$$

$$J = 131 \times 10^{10} \text{ mm}^4$$

$$\gamma_f = \frac{1}{1 + (2/3) \times \sqrt{2187/2187}} = 0.600$$

$$\gamma_v = 1 - \gamma_f = 1 - 0.600 = 0.400$$

CSA A23.3-14 (Eq. 13.8)

The length of the critical perimeter for the interior column:

$$b_o = 2 \times (2187 + 2187) = 8748 \text{ mm}$$

The two-way shear stress (v_f) can then be calculated as:

$$v_f = \frac{V_f}{b_o \times d} + \frac{\gamma_v M_{unb} c_{AB}}{J}$$

CSA A23.3-14 (Eq.13.9)

$$v_f = \frac{635.3 \times 1000}{8748 \times 187} + \frac{0.400 \times (11.5 \times 10^6) \times 1093.5}{131 \times 10^{10}}$$

$$v_f = 0.388 + 0.004 = 0.392 \text{ MPa}$$

It is worth noting that the 20% allowance from preliminary sizing appears not adequately anticipate the fraction of shear stress caused by unbalanced moment (1.0%) for two way shear check around the interior drop panel.

The factored resisting shear stress, V_r shall be the smallest of:

CSA A23.3-14 (13.3.4.1)

$$\text{a) } v_r = v_c = \left(1 + \frac{2}{\beta_c}\right) 0.19 \lambda \phi_c \sqrt{f'_c} = \left(1 + \frac{2}{600/400}\right) 0.19 \times 0.65 \times \sqrt{25} = 1.441 \text{ MPa}$$

$$\text{b) } v_r = v_c = \left(\frac{\alpha_s d}{b_o} + 0.19\right) \lambda \phi_c \sqrt{f'_c} = \left(\frac{4 \times 187}{8748} + 0.19\right) \times 1 \times 0.65 \times \sqrt{25} = 0.895 \text{ MPa}$$

$$\text{c) } v_r = v_c = 0.38 \lambda \phi_c \sqrt{f'_c} = 0.38 \times 1 \times 0.65 \times \sqrt{25} = 1.235 \text{ MPa}$$

$$v_r = v_c = 0.895 \text{ MPa}$$

Since $v_c \geq v_f$ at the critical section, the slab has adequate two-way shear strength around this drop panel.

c. Corner drop panel:

In this example, interior equivalent elastic frame strip was selected where it only have exterior and interior drop panels (no corner drop panel is included in this strip). Detailed calculations for two-way (punching) shear check around corner drop panels can be found in "[Two-Way Flat Slab \(Drop Panels\) Concrete Floor Analysis and Design \(CSA A23.3-14\)](#)" example available in the [design examples](#) page in [StructurePoint](#) website.

4. Serviceability Requirements (Deflection Check)

Since the slab thickness was selected based on the minimum slab thickness equations in CSA A23.3-14, the deflection calculations are not required. Detailed calculations of immediate and time-dependent deflections can be found in "[Two-Way Flat Slab \(Drop Panels\) Concrete Floor Analysis and Design \(CSA A23.3-14\)](#)" example available in the [design examples](#) page in [StructurePoint](#) website.

5. spSlab Software Program Model Solution

[spSlab](#) program utilizes the Elastic Frame Method described and illustrated in details here for modeling, analysis and design of two-way concrete floor slab systems. [spSlab](#) uses the exact geometry and boundary conditions provided as input to perform an elastic stiffness (matrix) analysis of the equivalent frame taking into account the torsional stiffness of the slabs framing into the column. It also takes into account the complications introduced by a large number of parameters such as vertical and torsional stiffness of transverse beams, the stiffening effect of drop panels, column capitals, and effective contribution of columns above and below the floor slab using the of equivalent column concept (*CSA A23.3-14 (13.8.2.6)*).

[spSlab](#) Program models the elastic frame as a design strip. The design strip is, then, separated by [spSlab](#) into column and middle strips. The program calculates the internal forces (Shear Force & Bending Moment), moment and shear capacity vs. demand diagrams for column and middle strips, instantaneous and long-term deflection results, and required flexural reinforcement for column and middle strips. The graphical and text results will be provided from the [spSlab](#) model in a future revision to this document.

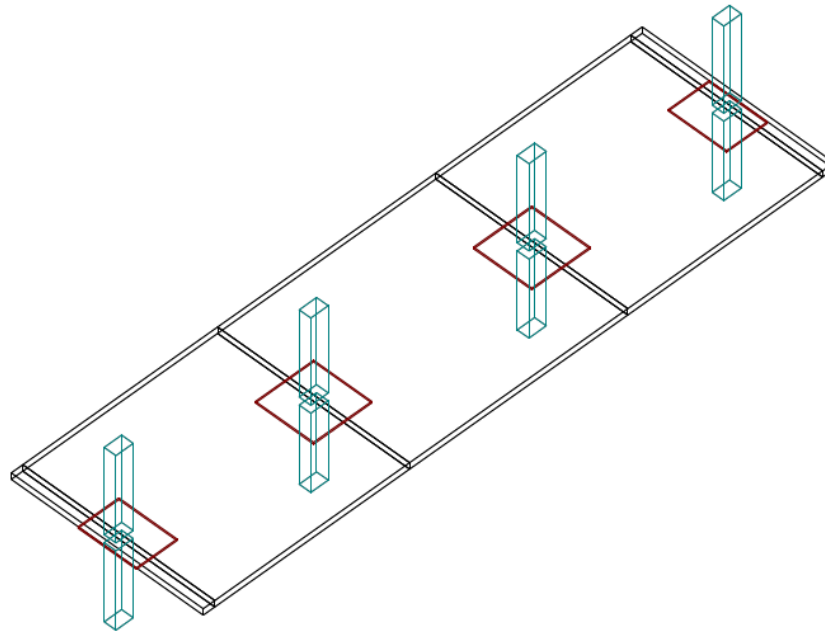

spSlab v5.50. Licensed to: StructurePoint. License ID:

File:

Project: CAC 4th Edition - Section 5.7 - Example 1

Frame: Interior

Engineer: SP

Code: CSA A23.3-14

Date: 05/09/19

Time: 10:10:12

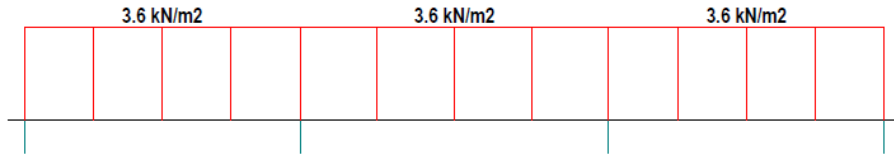

CASE/PATTERN: Live/All

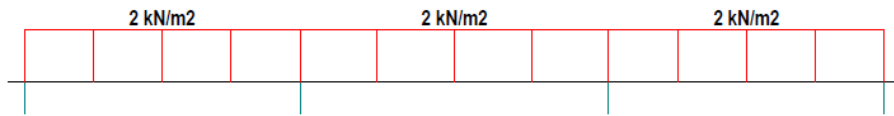

CASE: Dead

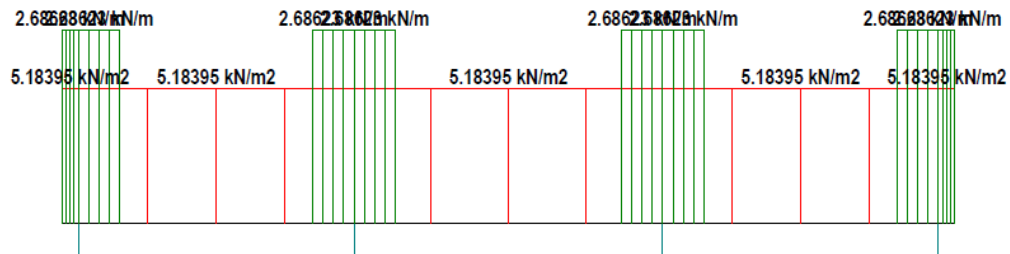

CASE: SELF

spSlab v5.50. Licensed to: StructurePoint. License ID:

File:
Project: CAC 4th Edition - Section 5.7 - Example 1
Frame: Interior
Engineer: SP
Code: CSA A23.3-14
Date: 05/09/19
Time: 10:10:52

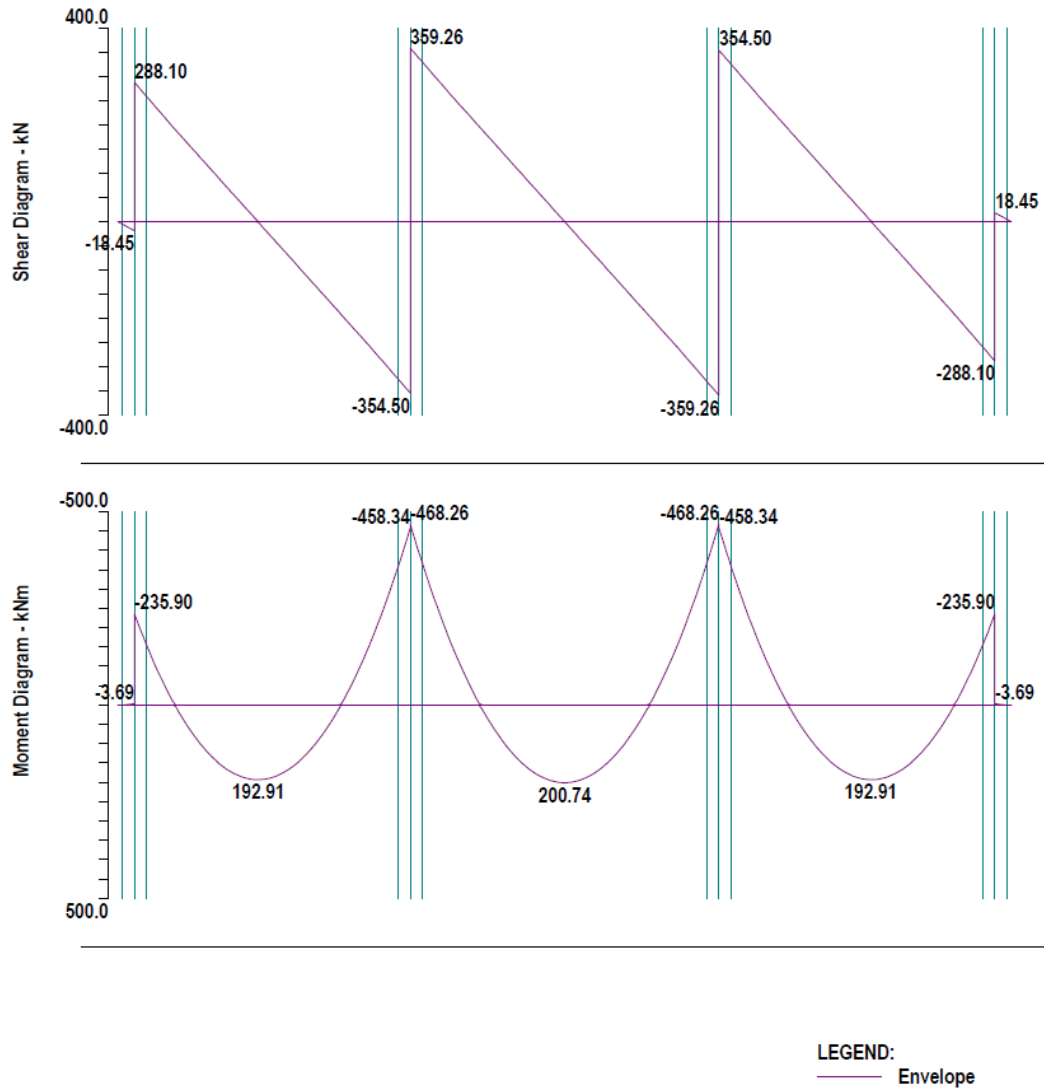

spSlab v5.50. Licensed to: StructurePoint. License ID:

File:
Project: CAC 4th Edition - Section 5.7 - Example 1
Frame: Interior
Engineer: SP
Code: CSA A23.3-14
Date: 05/09/19
Time: 10:11:27

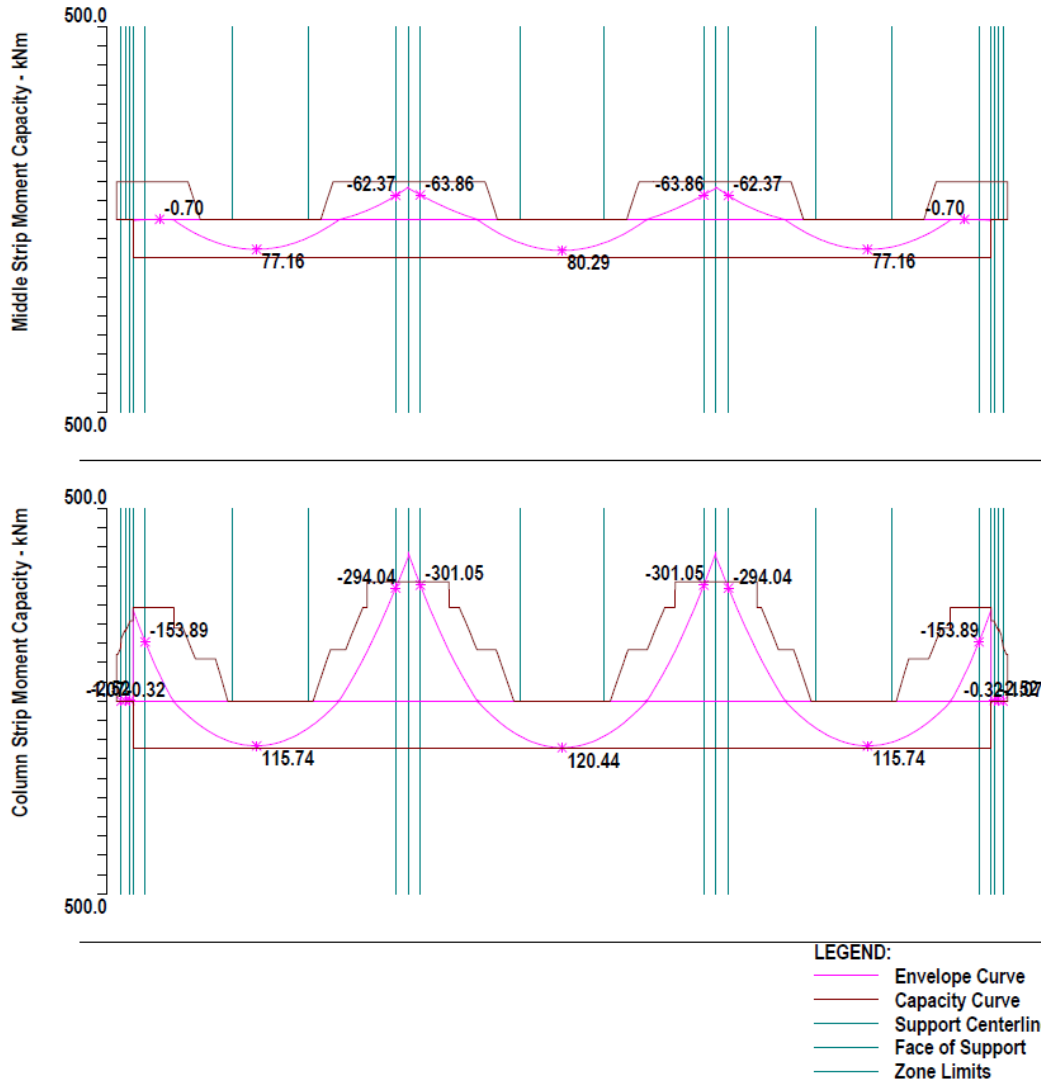

spSlab v5.50. Licensed to: StructurePoint. License ID:

File:
 Project: CAC 4th Edition - Section 5.7 - Example 1
 Frame: Interior
 Engineer: SP
 Code: CSA A23.3-14
 Date: 05/09/19
 Time: 10:12:10

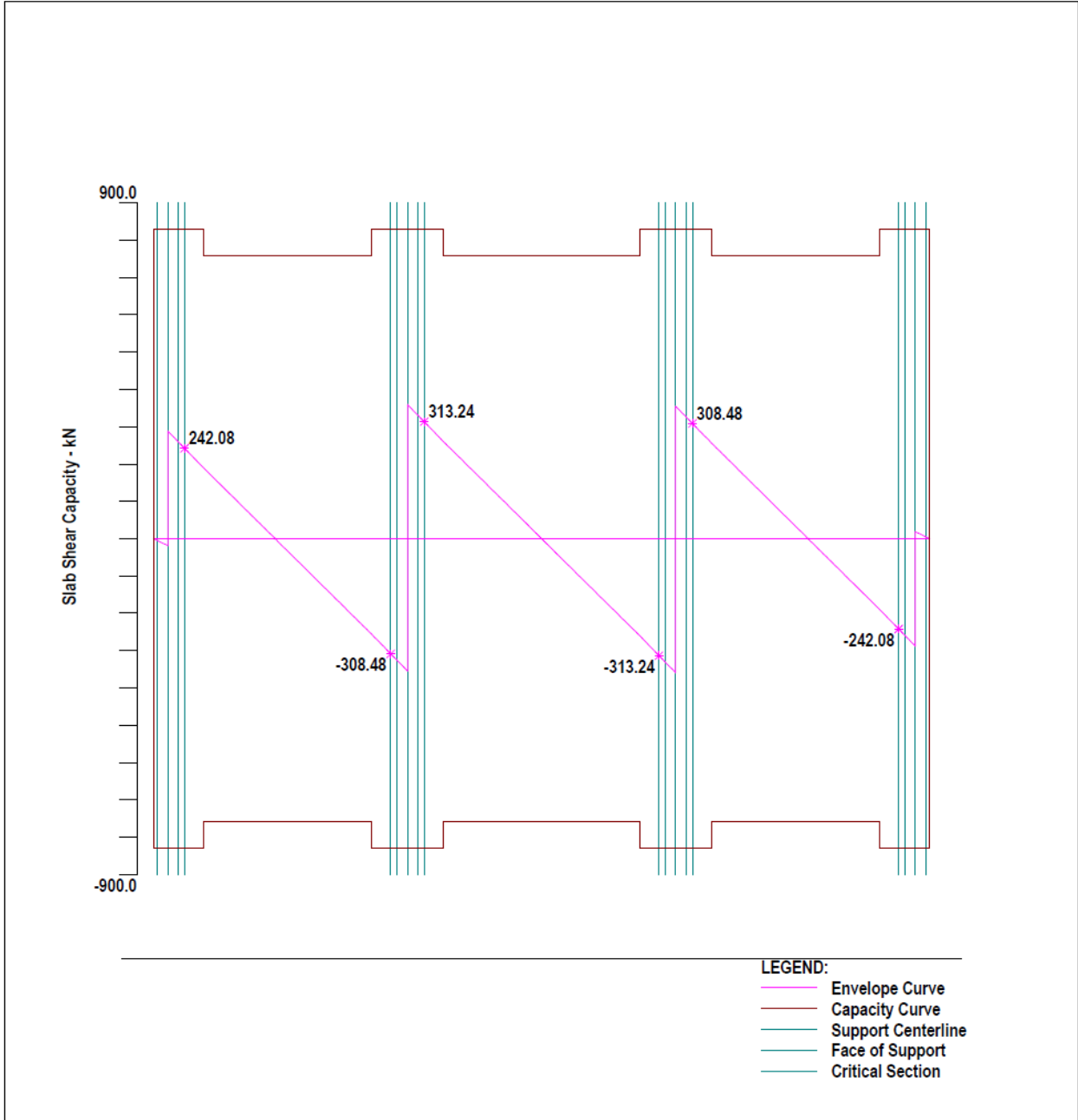

spSlab v5.50. Licensed to: StructurePoint. License ID:

File:
Project: CAC 4th Edition - Section 5.7 - Example 1
Frame: Interior
Engineer: SP
Code: CSA A23.3-14
Date: 05/09/19
Time: 10:12:43

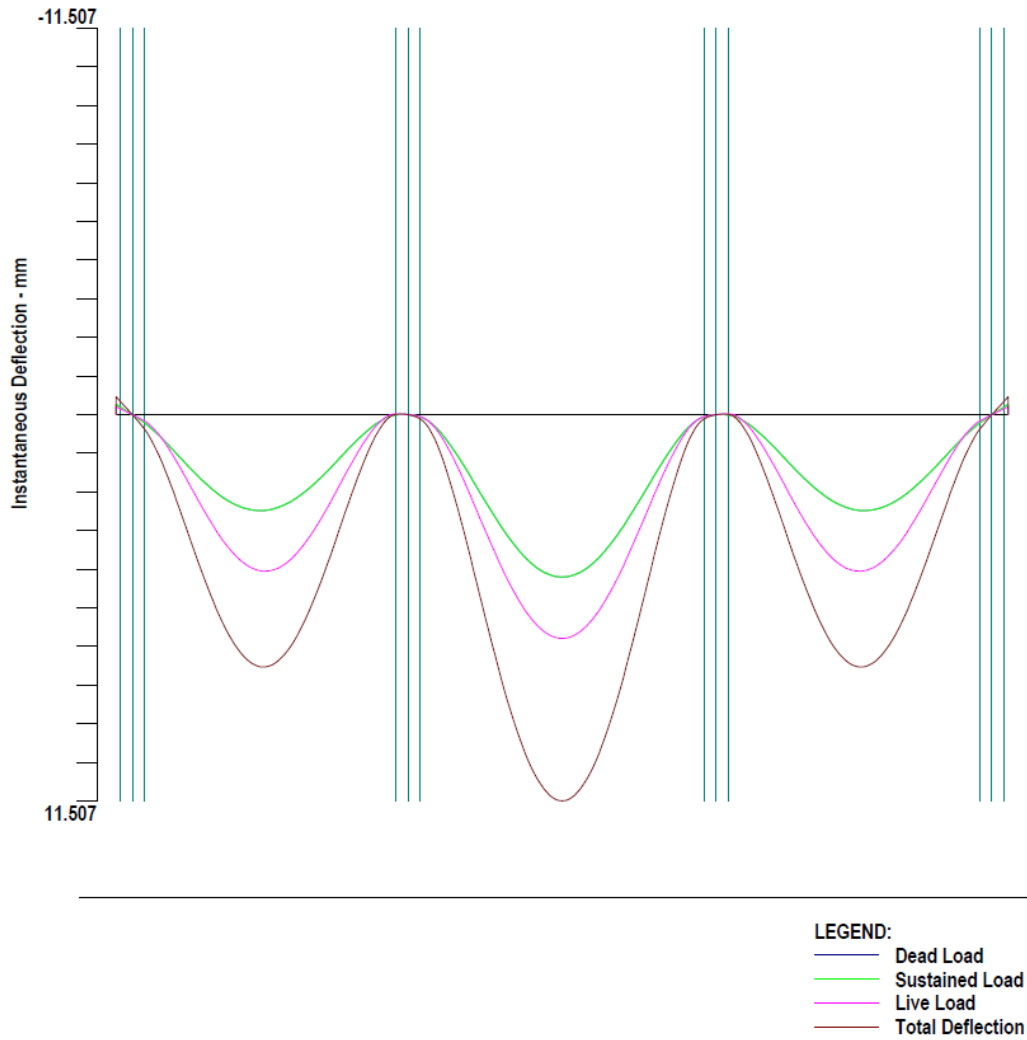

spSlab v5.50. Licensed to: StructurePoint. License ID:

File:
Project: CAC 4th Edition - Section 5.7 - Example 1
Frame: Interior
Engineer: SP
Code: CSA A23.3-14
Date: 05/09/19
Time: 10:13:08

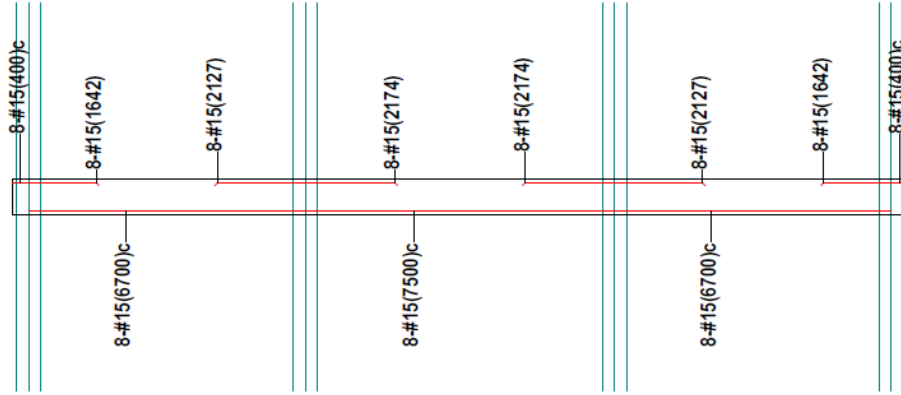

Middle Strip Flexural Reinforcement

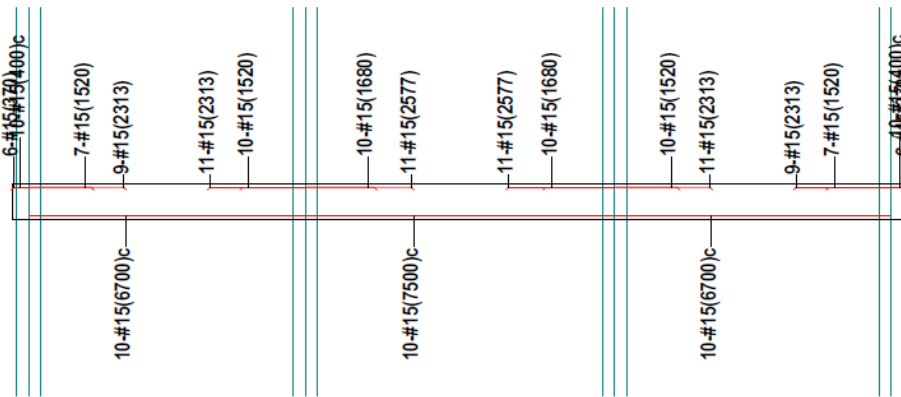

Column Strip Flexural Reinforcement

spSlab v5.50. Licensed to: StructurePoint. License ID:

File:
Project: CAC 4th Edition - Section 5.7 - Example 1
Frame: Interior
Engineer: SP
Code: CSA A23.3-14
Date: 05/09/19
Time: 10:13:27



spSlab v5.50
A Computer Program for Analysis, Design, and Investigation of
Reinforced Concrete Beams, One-way and Two-way Slab Systems
Copyright - 1988-2019, STRUCTUREPOINT, LLC.
All rights reserved

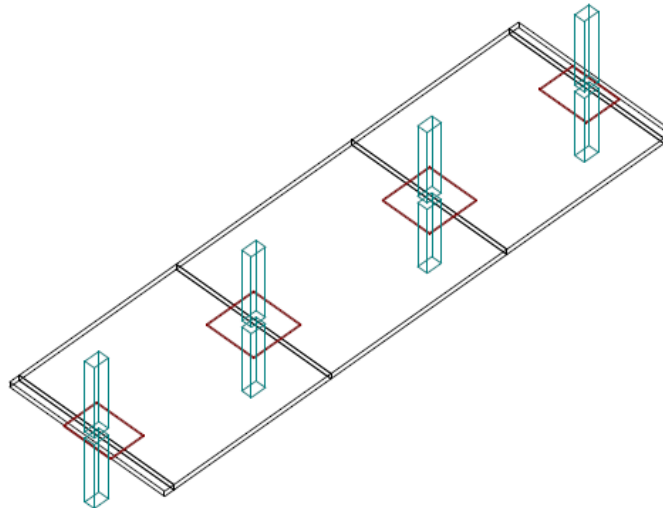

StructurePoint
Licensee stated above acknowledges that STRUCTUREPOINT (SP) is not and cannot be responsible for either the accuracy or adequacy of the material supplied as input for processing by the spSlab computer program. Furthermore, STRUCTUREPOINT neither makes any warranty expressed nor implied with respect to the correctness of the output prepared by the spSlab program. Although STRUCTUREPOINT has endeavored to produce spSlab error free the program is not and cannot be certified infallible. The final and only responsibility for analysis, design and engineering documents is the licensee's. Accordingly, STRUCTUREPOINT disclaims all responsibility in contract, negligence or other tort for any analysis, design or engineering documents prepared in connection with the use of the spSlab program. Licensed to: StructurePoint. License ID: 00000-0000000-4-25EF2-2C6B6

Contents

1. Input Echo.....	4
1.1. General Information.....	4
1.2. Solve Options.....	4
1.3. Material Properties.....	4
1.3.1. Concrete: Slabs / Beams.....	4
1.3.2. Concrete: Columns.....	4
1.3.3. Reinforcing Steel.....	5
1.4. Reinforcement Database.....	5
1.5. Span Data.....	5
1.5.1. Slabs.....	5
1.6. Support Data.....	5
1.6.1. Columns.....	5
1.6.2. Drop Panels.....	5
1.6.3. Boundary Conditions.....	5
1.7. Load Data.....	6
1.7.1. Load Cases and Combinations.....	6
1.7.2. Area Loads.....	6
1.7.3. Line Loads.....	6
1.8. Reinforcement Criteria.....	6
1.8.1. Slabs and Ribs.....	6
1.8.2. Beams.....	7
2. Design Results*.....	7
2.1. Strip Widths and Distribution Factors.....	7
2.2. Top Reinforcement.....	7
2.3. Top Bar Details.....	8
2.4. Top Bar Development Lengths.....	9
2.5. Band Reinforcement at Supports.....	9
2.6. Bottom Reinforcement.....	9
2.7. Bottom Bar Details.....	9
2.8. Bottom Bar Development Lengths.....	10
2.9. Flexural Capacity.....	10
2.10. Slab Shear Capacity.....	13
2.11. Flexural Transfer of Negative Unbalanced Moment at Supports.....	13
2.12. Punching Shear Around Columns.....	13
2.12.1. Critical Section Properties.....	13
2.12.2. Punching Shear Results.....	13
2.13. Punching Shear Around Drops.....	14
2.13.1. Critical Section Properties.....	14
2.13.2. Punching Shear Results.....	14
2.14. Integrity Reinforcement at Supports.....	14
2.15. Material TakeOff.....	14
2.15.1. Reinforcement in the Direction of Analysis.....	14
3. Deflection Results: Summary.....	14
3.1. Section Properties.....	14
3.1.1. Frame Section Properties.....	14
3.1.2. Frame Effective Section Properties.....	15
3.1.3. Strip Section Properties at Midspan.....	15
3.2. Instantaneous Deflections.....	15
3.2.1. Extreme Instantaneous Frame Deflections and Corresponding Locations.....	15
3.2.2. Extreme Instantaneous Column Strip Deflections and Corresponding Locations.....	16
3.2.3. Extreme Instantaneous Middle Strip Deflections and Corresponding Locations.....	16
3.3. Long-term Deflections.....	17
3.3.1. Long-term Column Strip Deflection Factors.....	17
3.3.2. Long-term Middle Strip Deflection Factors.....	17

3.3.3. Extreme Long-term Column Strip Deflections and Corresponding Locations.....17
3.3.4. Extreme Long-term Middle Strip Deflections and Corresponding Locations18

1. Input Echo

1.1. General Information

File Name	X:\exchange\AI Hijaj...\Slab with Drop Panels.slb
Project	CAC 4th Edition - Section 5.7 - Example 1
Frame	Interior
Engineer	SP
Code	CSA A23.3-14
Reinforcement Database	CSA G30.18
Mode	Design
Number of supports =	4 + Left cantilever + Right cantilever
Floor System	Two-Way

1.2. Solve Options

Live load pattern ratio = 0%
Minimum free edge distance for punching shear = 5 times slab effective depth.
Circular critical section around circular supports used (if possible).
Deflections are based on cracked section properties.
In negative moment regions, I_g and M_{cr} DO NOT include flange/slab contribution (if available)
Long-term deflections are calculated for load duration of 60 months.
0% of live load is sustained.
Compression reinforcement calculations NOT selected.
Default incremental rebar design selected.
Combined M-V-T reinforcement design NOT selected.
User-defined slab strip widths NOT selected.
User-defined distribution factors NOT selected.
One-way shear in drop panel selected.
Distribution of shear to strips NOT selected.
Beam T-section design NOT selected.
Longitudinal beam contribution in negative reinforcement design over support NOT selected.
Transverse beam contribution in negative reinforcement design over support NOT selected.

1.3. Material Properties

1.3.1. Concrete: Slabs / Beams

w_c	2402.8 kg/m ³
f'_c	25 MPa
E_c	24986 MPa
f_r	1.5 MPa
Precast concrete	No

1.3.2. Concrete: Columns

w_c	2402.8 kg/m ³
f'_c	25 MPa
E_c	24986 MPa
f_r	1.5 MPa
Precast concrete	No

1.3.3. Reinforcing Steel

f_y	400 MPa
f_{yt}	400 MPa
E_s	200000 MPa
Epoxy coated bars	No

1.4. Reinforcement Database

Size	Db mm	Ab mm ²	Wb kg/m	Size	Db mm	Ab mm ²	Wb kg/m
#10	11	100	1	#15	16	200	2
#20	20	300	2	#25	25	500	4
#30	30	700	5	#35	36	1000	8
#45	44	1500	12	#55	56	2500	20

1.5. Span Data

1.5.1. Slabs

Notes:

Deflection check required for panels where code-specified H_{min} for two-way construction doesn't apply due to:

*i - cantilever end span (LC, RC) support condition

Span	Loc	L1 m	t mm	wL m	wR m	L2L m	L2R m	H_{min} mm
1	Int	0.400	220	3.300	3.300	6.600	6.600	--- LC *i
2	Int	6.700	220	3.300	3.300	6.600	6.600	190
3	Int	7.500	220	3.300	3.300	6.600	6.600	218
4	Int	6.700	220	3.300	3.300	6.600	6.600	190
5	Int	0.400	220	3.300	3.300	6.600	6.600	--- RC *i

1.6. Support Data

1.6.1. Columns

Support	c1a mm	c2a mm	Ha m	c1b mm	c2b mm	Hb m	Red %
1	600	400	3.000	600	400	3.000	100
2	600	400	3.000	600	400	3.000	100
3	600	400	3.000	600	400	3.000	100
4	600	400	3.000	600	400	3.000	100

1.6.2. Drop Panels

Notes:

*e - Excessive drop thickness on left side of support will not be used for flexural design.

*f - Excessive drop thickness on right side of support will not be used for flexural design.

Support	h mm	LI m	Lr m	WI m	Wr m
1	57	0.400	1.000	1.000	1.000 *e
2	57	1.000	1.000	1.000	1.000
3	57	1.000	1.000	1.000	1.000
4	57	1.000	0.400	1.000	1.000 *f

1.6.3. Boundary Conditions

Support	Spring		Far End	
	K_z kN/mm	K_{ry} kN-mm/rad	Above	Below
1	0	0	Fixed	Fixed

Support	Spring		Far End	
	K _z kN/mm	K _{ry} kN-mm/rad	Above	Below
2	0	0	Fixed	Fixed
3	0	0	Fixed	Fixed
4	0	0	Fixed	Fixed

1.7. Load Data

1.7.1. Load Cases and Combinations

Case	SELF	Dead	Live
Type	DEAD	DEAD	LIVE
U1	1.250	1.250	1.500

1.7.2. Area Loads

Case/Patt	Span	Wa kN/m ²
SELF	1	5.18
	2	5.18
	3	5.18
	4	5.18
	5	5.18
Dead	2	2.00
	3	2.00
	4	2.00
Live	2	3.60
	3	3.60
	4	3.60

1.7.3. Line Loads

Case/Patt	Span	Wa kN/m	La m	Wb kN/m	Lb m
SELF	1	2.69	0.000	2.69	0.400
	2	2.69	0.000	2.69	1.000
	2	2.69	5.700	2.69	6.700
	3	2.69	0.000	2.69	1.000
	3	2.69	6.500	2.69	7.500
	4	2.69	0.000	2.69	1.000
	4	2.69	5.700	2.69	6.700
	5	2.69	0.000	2.69	0.400

1.8. Reinforcement Criteria

1.8.1. Slabs and Ribs

	Units	Top Bars		Bottom Bars	
		Min.	Max.	Min.	Max.
Bar Size		#15	#15	#15	#15
Bar spacing	mm	25	500	25	500
Reinf ratio	%	0.14	5.00	0.14	5.00
Clear Cover	mm	25		25	

There is NOT more than 300 mm of concrete below top bars.

1.8.2. Beams

	Units	Top Bars		Bottom Bars		Stirrups	
		Min.	Max.	Min.	Max.	Min.	Max.
Bar Size		#20	#35	#20	#35	#10	#20
Bar spacing	mm	25	457	25	457	152	457
Reinf ratio	%	0.14	5.00	0.14	5.00		
Clear Cover	mm	38		38			
Layer dist.	mm	25		25			
No. of legs						2	6
Side cover	mm					38	
1st Stirrup	mm					76	

There is NOT more than 300 mm of concrete below top bars.

2. Design Results*

*Unless otherwise noted, all results are in the direction of analysis only. Another analysis in the perpendicular direction has to be carried out for two-way slab systems.

2.1. Strip Widths and Distribution Factors

Notes:

*Used for bottom reinforcement. **Used for top reinforcement.

Span	Strip	Width			Moment Factor		
		Left **	Right **	Bottom *	Left **	Right **	Bottom *
		m	m	m	m	m	m
1	Column	3.30	3.30	3.30	1.000	1.000	0.600
	Middle	3.30	3.30	3.30	0.000	0.000	0.400
2	Column	3.30	3.30	3.30	1.000	0.825	0.600
	Middle	3.30	3.30	3.30	0.000	0.175	0.400
3	Column	3.30	3.30	3.30	0.825	0.825	0.600
	Middle	3.30	3.30	3.30	0.175	0.175	0.400
4	Column	3.30	3.30	3.30	0.825	1.000	0.600
	Middle	3.30	3.30	3.30	0.175	0.000	0.400
5	Column	3.30	3.30	3.30	1.000	1.000	0.600
	Middle	3.30	3.30	3.30	0.000	0.000	0.400

2.2. Top Reinforcement

Notes:

*3 - Design governed by minimum reinforcement.

*5 - Number of bars governed by maximum allowable spacing.

Span	Strip	Zone	Width m	M _{max} kNm	X _{max} m	A _{s,min} mm ²	A _{s,max} mm ²	A _{s,req} mm ²	Sp _{Prov} mm	Bars
1	Column	Left	3.30	0.32	0.115	1452	13839	5	330	10-#15 *3
		Midspan	3.30	1.07	0.215	1452	15689	15	330	10-#15 *3
		Right	3.30	2.52	0.330	1552	9509	35	206	16-#15 *3 *5
	Middle	Left	3.30	0.00	0.000	1452	13839	0	413	8-#15 *3
		Midspan	3.30	0.00	0.165	1452	13839	0	413	8-#15 *3
		Right	3.30	0.00	0.330	1452	13839	0	413	8-#15 *3
2	Column	Left	3.30	153.89	0.300	1680	10944	1956	206	16-#15
		Midspan	3.30	0.00	3.350	0	13839	0	0	---

Span Strip	Zone	Width m	M _{max} kNm	X _{max} m	A _{s,min} mm ²	A _{s,max} mm ²	A _{s,req} mm ²	S _{p,prov} mm	Bars
	Right	3.30	294.04	6.400	1680	10944	3958	157	21-#15
Middle	Left	3.30	0.70	0.650	1452	13839	11	413	8-#15 *3
	Midspan	3.30	0.00	3.350	0	13839	0	0	---
	Right	3.30	62.37	6.400	1452	13839	1002	413	8-#15 *3
3 Column	Left	3.30	301.05	0.300	1680	10944	4065	157	21-#15
	Midspan	3.30	0.00	3.750	0	13839	0	0	---
	Right	3.30	301.05	7.200	1680	10944	4065	157	21-#15
Middle	Left	3.30	63.86	0.300	1452	13839	1026	413	8-#15 *3
	Midspan	3.30	0.00	3.750	0	13839	0	0	---
	Right	3.30	63.86	7.200	1452	13839	1026	413	8-#15 *3
4 Column	Left	3.30	294.04	0.300	1680	10944	3958	157	21-#15
	Midspan	3.30	0.00	3.350	0	13839	0	0	---
	Right	3.30	153.89	6.400	1680	10944	1956	206	16-#15
Middle	Left	3.30	62.37	0.300	1452	13839	1002	413	8-#15 *3
	Midspan	3.30	0.00	3.350	0	13839	0	0	---
	Right	3.30	0.70	6.050	1452	13839	11	413	8-#15 *3
5 Column	Left	3.30	2.52	0.070	1552	9509	35	206	16-#15 *3 *5
	Midspan	3.30	1.07	0.186	1452	15689	15	330	10-#15 *3
	Right	3.30	0.32	0.285	1452	13839	5	330	10-#15 *3
Middle	Left	3.30	0.00	0.070	1452	13839	0	413	8-#15 *3
	Midspan	3.30	0.00	0.235	1452	13839	0	413	8-#15 *3
	Right	3.30	0.00	0.400	1452	13839	0	413	8-#15 *3

2.3. Top Bar Details

NOTES:

* - Bar cut-off location shall be manually checked for compliance with CSA A23.3, 11.2.13.

Span Strip	Bars	Left		Continuous		Right			
		Length m	Bars	Length m	Bars	Length m	Bars	Length m	Bars
1 Column	---	---	---	10-#15	0.40	6-#15 *	0.37	---	---
Middle	---	---	---	8-#15	0.40	---	---	---	---
2 Column	9-#15	2.31	7-#15	1.52	---	11-#15	2.31	10-#15 *	1.52
Middle	8-#15	1.64	---	---	---	8-#15	2.13	---	---
3 Column	11-#15	2.58	10-#15 *	1.68	---	11-#15	2.58	10-#15 *	1.68
Middle	8-#15	2.17	---	---	---	8-#15	2.17	---	---
4 Column	11-#15	2.31	10-#15 *	1.52	---	9-#15	2.31	7-#15	1.52
Middle	8-#15	2.13	---	---	---	8-#15	1.64	---	---
5 Column	6-#15 *	0.37	---	---	10-#15	0.40	---	---	---
Middle	---	---	---	---	8-#15	0.40	---	---	---

2.4. Top Bar Development Lengths

Span Strip	Left				Continuous		Right			
	Bars	DevLen mm	Bars	DevLen mm	Bars	DevLen mm	Bars	DevLen mm	Bars	DevLen mm
1 Column	---		---		10-#15	300.00	6-#15	300.00	---	
1 Middle	---		---		8-#15	300.00	---		---	
2 Column	9-#15	300.00	7-#15	300.00	---		11-#15	422.55	10-#15	422.55
2 Middle	8-#15	300.00	---		---		8-#15	300.00	---	
3 Column	11-#15	433.99	10-#15	433.99	---		11-#15	433.99	10-#15	433.99
3 Middle	8-#15	300.00	---		---		8-#15	300.00	---	
4 Column	11-#15	422.55	10-#15	422.55	---		9-#15	300.00	7-#15	300.00
4 Middle	8-#15	300.00	---		---		8-#15	300.00	---	
5 Column	6-#15	300.00	---		10-#15	300.00	---		---	
5 Middle	---		---		8-#15	300.00	---		---	

2.5. Band Reinforcement at Supports

NOTES:

<C> Total Strip, Banded Strip, <S> Remaining Strip

Support	Width <C> mm	Width mm	Width <S> mm	A _s <C> mm ²	A _s mm ²	A _s <S> mm ²	Bars <C>	Bars 	Bars <S>
1	3300	1231	2069	3200	2000	1200	16-#15	10-#15	6-#15
2	3300	1231	2069	4200	1800	2400	21-#15	9-#15	12-#15
3	3300	1231	2069	4200	1800	2400	21-#15	9-#15	12-#15
4	3300	1231	2069	3200	2000	1200	16-#15	10-#15	6-#15

2.6. Bottom Reinforcement

Notes:

*3 - Design governed by minimum reinforcement.

Span Strip	Width m	M _{max} kNm	X _{max} m	A _{s,min} mm ²	A _{s,max} mm ²	A _{s,req} mm ²	Sp _{Prov} mm	Bars
1 Column	3.30	0.00	0.165	0	13839	0	0	---
1 Middle	3.30	0.00	0.165	0	13839	0	0	---
2 Column	3.30	115.74	3.014	1452	13839	1895	330	10-#15
2 Middle	3.30	77.16	3.014	1452	13839	1246	413	8-#15 *3
3 Column	3.30	120.44	3.750	1452	13839	1976	330	10-#15
3 Middle	3.30	80.29	3.750	1452	13839	1298	413	8-#15 *3
4 Column	3.30	115.74	3.686	1452	13839	1895	330	10-#15
4 Middle	3.30	77.16	3.686	1452	13839	1246	413	8-#15 *3
5 Column	3.30	0.00	0.235	0	13839	0	0	---
5 Middle	3.30	0.00	0.235	0	13839	0	0	---

2.7. Bottom Bar Details

Span Strip	Long Bars			Short Bars		
	Bars	Start m	Length m	Bars	Start m	Length m
1 Column	---			---		

Span Strip	Long Bars			Short Bars		
	Bars	Start m	Length m	Bars	Start m	Length m
Middle	---			---		
2 Column	10-#15	0.00	6.70	---		
Middle	8-#15	0.00	6.70	---		
3 Column	10-#15	0.00	7.50	---		
Middle	8-#15	0.00	7.50	---		
4 Column	10-#15	0.00	6.70	---		
Middle	8-#15	0.00	6.70	---		
5 Column	---			---		
Middle	---			---		

2.8. Bottom Bar Development Lengths

Span Strip	Long Bars		Short Bars	
	Bars	DevLen mm	Bars	DevLen mm
1 Column	---		---	
Middle	---		---	
2 Column	10-#15	424.98	---	
Middle	8-#15	349.22	---	
3 Column	10-#15	443.00	---	
Middle	8-#15	363.80	---	
4 Column	10-#15	424.98	---	
Middle	8-#15	349.22	---	
5 Column	---		---	
Middle	---		---	

2.9. Flexural Capacity

Span Strip	x m	Top					Bottom					
		A _{s,top} mm ²	ΦM _{n-} kNm	M _{u-} kNm	Comb Pat	Status	A _{s,bot} mm ²	ΦM _{n+} kNm	M _{u+} kNm	Comb Pat	Status	
1 Column	0.000	2000	-121.85	0.00	U1 All	OK	0	0.00	0.00	U1 All	OK	
	0.030	2000	-121.85	-0.03	U1 All	OK	0	0.00	0.00	U1 All	OK	
	0.115	2342	-161.54	-0.32	U1 All	OK	0	0.00	0.00	U1 All	OK	
	0.200	2680	-183.65	-0.94	U1 All	OK	0	0.00	0.00	U1 All	OK	
	0.215	2738	-180.95	-1.07	U1 All	OK	0	0.00	0.00	U1 All	OK	
	0.330	3200	-208.24	-2.52	U1 All	OK	0	0.00	0.00	U1 All	OK	
	0.400	3200	-208.24	-3.69	U1 All	---	0	0.00	0.00	U1 All	---	
	Middle	0.000	1600	-98.33	0.00	U1 All	OK	0	0.00	0.00	U1 All	OK
		0.115	1600	-98.33	0.00	U1 All	OK	0	0.00	0.00	U1 All	OK
		0.200	1600	-98.33	0.00	U1 All	OK	0	0.00	0.00	U1 All	OK
		0.215	1600	-98.33	0.00	U1 All	OK	0	0.00	0.00	U1 All	OK
		0.330	1600	-98.33	0.00	U1 All	OK	0	0.00	0.00	U1 All	OK
		0.400	1600	-98.33	0.00	U1 All	---	0	0.00	0.00	U1 All	---
	2 Column	0.000	3200	-243.06	-237.93	U1 All	---	2000	121.85	0.00	U1 All	---

Span Strip	x m	Top					Bottom				
		A _{s,top} mm ²	ΦM _{n-} kNm	M _{u-} kNm	Comb Pat	Status	A _{s,bot} mm ²	ΦM _{n+} kNm	M _{u+} kNm	Comb Pat	Status
	0.300	3200	-243.06	-153.89	U1 All	OK	2000	121.85	0.00	U1 All	OK
	1.000	3200	-243.06	0.00	U1 All	OK	2000	121.85	1.80	U1 All	OK
	1.000	3200	-189.87	0.00	U1 All	OK	2000	121.85	1.87	U1 All	OK
	1.220	3200	-189.87	0.00	U1 All	OK	2000	121.85	25.51	U1 All	OK
	1.520	1800	-110.15	0.00	U1 All	OK	2000	121.85	53.36	U1 All	OK
	2.013	1800	-110.15	0.00	U1 All	OK	2000	121.85	87.96	U1 All	OK
	2.313	0	0.00	0.00	U1 All	OK	2000	121.85	102.27	U1 All	OK
	2.435	0	0.00	0.00	U1 All	OK	2000	121.85	106.63	U1 All	OK
	3.014	0	0.00	0.00	U1 All	OK	2000	121.85	115.74	U1 All	OK
	3.350	0	0.00	0.00	U1 All	OK	2000	121.85	112.23	U1 All	OK
	4.265	0	0.00	0.00	U1 All	OK	2000	121.85	70.17	U1 All	OK
	4.387	0	0.00	0.00	U1 All	OK	2000	121.85	60.95	U1 All	OK
	4.810	2200	-133.46	0.00	U1 All	OK	2000	121.85	22.53	U1 All	OK
	5.180	2200	-133.46	-28.01	U1 All	OK	2000	121.85	0.00	U1 All	OK
	5.603	4200	-243.63	-108.96	U1 All	OK	2000	121.85	0.00	U1 All	OK
	5.700	4200	-243.63	-129.21	U1 All	OK	2000	121.85	0.00	U1 All	OK
	5.700	4200	-309.82	-129.34	U1 All	OK	2000	121.85	0.00	U1 All	OK
	6.400	4200	-309.82	-294.04	U1 All	OK	2000	121.85	0.00	U1 All	OK
	6.475	4200	-309.82	-313.56	U1 All	---	2000	121.85	0.00	U1 All	---
	6.700	4200	-309.82	-374.19	U1 All	---	2000	121.85	0.00	U1 All	---
Middle	0.000	1600	-98.33	2.03	U1 All	---	1600	98.33	0.00	U1 All	---
	0.300	1600	-98.33	0.00	U1 All	OK	1600	98.33	0.00	U1 All	OK
	0.650	1600	-98.33	-0.70	U1 All	OK	1600	98.33	0.00	U1 All	OK
	1.342	1600	-98.33	0.00	U1 All	OK	1600	98.33	24.95	U1 All	OK
	1.642	0	0.00	0.00	U1 All	OK	1600	98.33	42.13	U1 All	OK
	2.435	0	0.00	0.00	U1 All	OK	1600	98.33	71.08	U1 All	OK
	3.014	0	0.00	0.00	U1 All	OK	1600	98.33	77.16	U1 All	OK
	3.350	0	0.00	0.00	U1 All	OK	1600	98.33	74.82	U1 All	OK
	4.265	0	0.00	0.00	U1 All	OK	1600	98.33	46.78	U1 All	OK
	4.573	0	0.00	0.00	U1 All	OK	1600	98.33	30.22	U1 All	OK
	4.873	1600	-98.33	0.00	U1 All	OK	1600	98.33	10.60	U1 All	OK
	6.400	1600	-98.33	-62.37	U1 All	OK	1600	98.33	0.00	U1 All	OK
	6.700	1600	-98.33	-84.15	U1 All	---	1600	98.33	0.00	U1 All	---
3 Column	0.000	4200	-309.82	-386.32	U1 All	---	2000	121.85	0.00	U1 All	---
	0.240	4200	-309.82	-317.52	U1 All	---	2000	121.85	0.00	U1 All	---
	0.300	4200	-309.82	-301.05	U1 All	OK	2000	121.85	0.00	U1 All	OK
	1.000	4200	-309.82	-130.53	U1 All	OK	2000	121.85	0.00	U1 All	OK
	1.000	4200	-243.63	-130.40	U1 All	OK	2000	121.85	0.00	U1 All	OK
	1.246	4200	-243.63	-79.90	U1 All	OK	2000	121.85	0.00	U1 All	OK
	1.680	2200	-133.46	-2.17	U1 All	OK	2000	121.85	0.00	U1 All	OK
	2.143	2200	-133.46	0.00	U1 All	OK	2000	121.85	46.88	U1 All	OK
	2.577	0	0.00	0.00	U1 All	OK	2000	121.85	81.24	U1 All	OK
	2.715	0	0.00	0.00	U1 All	OK	2000	121.85	89.93	U1 All	OK
	3.750	0	0.00	0.00	U1 All	OK	2000	121.85	120.44	U1 All	OK
	4.785	0	0.00	0.00	U1 All	OK	2000	121.85	89.93	U1 All	OK
	4.923	0	0.00	0.00	U1 All	OK	2000	121.85	81.24	U1 All	OK
	5.357	2200	-133.46	0.00	U1 All	OK	2000	121.85	46.88	U1 All	OK
	5.820	2200	-133.46	-2.17	U1 All	OK	2000	121.85	0.00	U1 All	OK
	6.254	4200	-243.63	-79.90	U1 All	OK	2000	121.85	0.00	U1 All	OK
	6.500	4200	-243.63	-130.40	U1 All	OK	2000	121.85	0.00	U1 All	OK
	6.500	4200	-309.82	-130.53	U1 All	OK	2000	121.85	0.00	U1 All	OK
	7.200	4200	-309.82	-301.05	U1 All	OK	2000	121.85	0.00	U1 All	OK
	7.275	4200	-309.82	-321.68	U1 All	---	2000	121.85	0.00	U1 All	---

Span Strip	x m	Top					Bottom				
		A _{s,top} mm ²	ΦM _{n-} kNm	M _{u-} kNm	Comb Pat	Status	A _{s,bot} mm ²	ΦM _{n+} kNm	M _{u+} kNm	Comb Pat	Status
Middle	7.500	4200	-309.82	-386.32	U1 All	---	2000	121.85	0.00	U1 All	---
	0.000	1600	-98.33	-81.95	U1 All	---	1600	98.33	0.00	U1 All	---
	0.300	1600	-98.33	-63.86	U1 All	OK	1600	98.33	0.00	U1 All	OK
	1.874	1600	-98.33	0.00	U1 All	OK	1600	98.33	13.51	U1 All	OK
	2.174	0	0.00	0.00	U1 All	OK	1600	98.33	33.16	U1 All	OK
	2.715	0	0.00	0.00	U1 All	OK	1600	98.33	59.95	U1 All	OK
	3.750	0	0.00	0.00	U1 All	OK	1600	98.33	80.29	U1 All	OK
	4.785	0	0.00	0.00	U1 All	OK	1600	98.33	59.95	U1 All	OK
	5.326	0	0.00	0.00	U1 All	OK	1600	98.33	33.16	U1 All	OK
	5.626	1600	-98.33	0.00	U1 All	OK	1600	98.33	13.51	U1 All	OK
	7.200	1600	-98.33	-63.86	U1 All	OK	1600	98.33	0.00	U1 All	OK
7.500	1600	-98.33	-81.95	U1 All	---	1600	98.33	0.00	U1 All	---	
4 Column	0.000	4200	-309.82	-374.19	U1 All	---	2000	121.85	0.00	U1 All	---
	0.180	4200	-309.82	-325.44	U1 All	---	2000	121.85	0.00	U1 All	---
	0.300	4200	-309.82	-294.04	U1 All	OK	2000	121.85	0.00	U1 All	OK
	1.000	4200	-309.82	-129.34	U1 All	OK	2000	121.85	0.00	U1 All	OK
	1.000	4200	-243.63	-129.21	U1 All	OK	2000	121.85	0.00	U1 All	OK
	1.097	4200	-243.63	-108.96	U1 All	OK	2000	121.85	0.00	U1 All	OK
	1.520	2200	-133.46	-28.01	U1 All	OK	2000	121.85	0.00	U1 All	OK
	1.890	2200	-133.46	0.00	U1 All	OK	2000	121.85	22.53	U1 All	OK
	2.313	0	0.00	0.00	U1 All	OK	2000	121.85	60.95	U1 All	OK
	2.435	0	0.00	0.00	U1 All	OK	2000	121.85	70.17	U1 All	OK
	3.350	0	0.00	0.00	U1 All	OK	2000	121.85	112.23	U1 All	OK
	3.686	0	0.00	0.00	U1 All	OK	2000	121.85	115.74	U1 All	OK
	4.265	0	0.00	0.00	U1 All	OK	2000	121.85	106.63	U1 All	OK
	4.387	0	0.00	0.00	U1 All	OK	2000	121.85	102.27	U1 All	OK
	4.687	1800	-110.15	0.00	U1 All	OK	2000	121.85	87.96	U1 All	OK
	5.180	1800	-110.15	0.00	U1 All	OK	2000	121.85	53.36	U1 All	OK
	5.480	3200	-189.87	0.00	U1 All	OK	2000	121.85	25.51	U1 All	OK
	5.700	3200	-189.87	0.00	U1 All	OK	2000	121.85	1.87	U1 All	OK
	5.700	3200	-243.06	0.00	U1 All	OK	2000	121.85	1.80	U1 All	OK
6.400	3200	-243.06	-153.89	U1 All	OK	2000	121.85	0.00	U1 All	OK	
6.700	3200	-243.06	-237.93	U1 All	---	2000	121.85	0.00	U1 All	---	
Middle	0.000	1600	-98.33	-84.15	U1 All	---	1600	98.33	0.00	U1 All	---
	0.300	1600	-98.33	-62.37	U1 All	OK	1600	98.33	0.00	U1 All	OK
	1.827	1600	-98.33	0.00	U1 All	OK	1600	98.33	10.60	U1 All	OK
	2.127	0	0.00	0.00	U1 All	OK	1600	98.33	30.22	U1 All	OK
	2.435	0	0.00	0.00	U1 All	OK	1600	98.33	46.78	U1 All	OK
	3.350	0	0.00	0.00	U1 All	OK	1600	98.33	74.82	U1 All	OK
	3.686	0	0.00	0.00	U1 All	OK	1600	98.33	77.16	U1 All	OK
	4.265	0	0.00	0.00	U1 All	OK	1600	98.33	71.08	U1 All	OK
	5.058	0	0.00	0.00	U1 All	OK	1600	98.33	42.13	U1 All	OK
	5.358	1600	-98.33	0.00	U1 All	OK	1600	98.33	24.95	U1 All	OK
	6.050	1600	-98.33	-0.70	U1 All	OK	1600	98.33	0.00	U1 All	OK
	6.400	1600	-98.33	0.00	U1 All	OK	1600	98.33	0.00	U1 All	OK
	6.700	1600	-98.33	2.03	U1 All	---	1600	98.33	0.00	U1 All	---
5 Column	0.000	3200	-208.24	-3.69	U1 All	---	0	0.00	0.00	U1 All	---
	0.070	3200	-208.24	-2.52	U1 All	OK	0	0.00	0.00	U1 All	OK
	0.186	2738	-187.41	-1.07	U1 All	OK	0	0.00	0.00	U1 All	OK
	0.200	2680	-183.65	-0.94	U1 All	OK	0	0.00	0.00	U1 All	OK
	0.285	2342	-141.63	-0.32	U1 All	OK	0	0.00	0.00	U1 All	OK
	0.370	2000	-121.85	-0.03	U1 All	OK	0	0.00	0.00	U1 All	OK

Span Strip	Top						Bottom				
	x m	A _{s,top} mm ²	ΦM _{n-} kNm	M _{u-} kNm	Comb Pat	Status	A _{s,bot} mm ²	ΦM _{n+} kNm	M _{u+} kNm	Comb Pat	Status
Middle	0.400	2000	-121.85	0.00	U1 All	OK	0	0.00	0.00	U1 All	OK
	0.000	1600	-98.33	0.00	U1 All	---	0	0.00	0.00	U1 All	---
	0.070	1600	-98.33	0.00	U1 All	OK	0	0.00	0.00	U1 All	OK
	0.186	1600	-98.33	0.00	U1 All	OK	0	0.00	0.00	U1 All	OK
	0.200	1600	-98.33	0.00	U1 All	OK	0	0.00	0.00	U1 All	OK
	0.285	1600	-98.33	0.00	U1 All	OK	0	0.00	0.00	U1 All	OK
	0.400	1600	-98.33	0.00	U1 All	OK	0	0.00	0.00	U1 All	OK

2.10. Slab Shear Capacity

Span	b mm	d _v mm	β	V _{ratio}	ΦV _c kN	V _u kN	X _u m
1	6600	168	0.000	1.000	758.11	0.00	0.00
	6600	184	0.000	1.000	828.13	0.00	0.00
2	6600	184	0.000	1.000	828.13	242.08	0.47
	6600	168	0.000	1.000	758.11	256.23	5.70
3	6600	184	0.000	1.000	828.13	308.48	6.23
	6600	184	0.000	1.000	828.13	313.24	0.47
	6600	168	0.000	1.000	758.11	261.00	1.00
4	6600	184	0.000	1.000	828.13	313.24	7.03
	6600	184	0.000	1.000	828.13	308.48	0.47
5	6600	168	0.000	1.000	758.11	256.23	1.00
	6600	184	0.000	1.000	828.13	242.08	6.23
	6600	184	0.000	1.000	828.13	0.00	0.40
	6600	168	0.000	1.000	758.11	0.00	0.40

2.11. Flexural Transfer of Negative Unbalanced Moment at Supports

Support	Width mm	Width-c mm	d mm	M _{unb} kNm	Comb Patt	γ _r	A _{s,req} mm ²	A _{s,prov} mm ²	Add Bars
1	1231	1231	244	232.21	U1 All	0.570	1724	2000	---
2	1231	1231	244	9.92	U1 All	0.567	68	1800	---
3	1231	1231	244	9.92	U1 All	0.567	68	1800	---
4	1231	1231	244	232.21	U1 All	0.570	1724	2000	---

2.12. Punching Shear Around Columns

2.12.1. Critical Section Properties

Support	Type	b ₁ mm	b ₂ mm	b ₀ mm	d _{avg} mm	CG mm	c _(left) mm	c _(right) mm	A _c mm ²	J _c mm ⁴
1	Rect	822.0	644.0	2288.0	244.0	126.7	526.7	295.3	5.5827e+005	4.3649e+010
2	Rect	844.0	644.0	2976.0	244.0	0.0	422.0	422.0	7.2614e+005	8.246e+010
3	Rect	844.0	644.0	2976.0	244.0	0.0	422.0	422.0	7.2614e+005	8.246e+010
4	Rect	822.0	644.0	2288.0	244.0	-126.7	295.3	526.7	5.5827e+005	4.3649e+010

2.12.2. Punching Shear Results

Support	V _u kN	v _u N/mm ²	M _{unb} kNm	Comb	Patt	γ _v	v _u N/mm ²	ΦV _c N/mm ²
1	300.97	0.539	194.08	U1	All	0.430	1.103	1.235
2	705.94	0.972	9.92	U1	All	0.433	0.994	1.235
3	705.94	0.972	-9.92	U1	All	0.433	0.994	1.235
4	300.97	0.539	-194.08	U1	All	0.430	1.103	1.235

2.13. Punching Shear Around Drops

2.13.1. Critical Section Properties

Support	Type	b ₁ mm	b ₂ mm	b ₀ mm	d _{avg} mm	CG mm	C _(left) mm	C _(right) mm	A _c mm ²	J _c mm ⁴
1	Rect	1493.5	2187.0	5174.0	187.0	662.4	1062.4	431.1	9.6754e+005	2.3711e+011
2	Rect	2187.0	2187.0	8748.0	187.0	0.0	1093.5	1093.5	1.6359e+006	1.3064e+012
3	Rect	2187.0	2187.0	8748.0	187.0	0.0	1093.5	1093.5	1.6359e+006	1.3064e+012
4	Rect	1493.5	2187.0	5174.0	187.0	-662.4	431.1	1062.4	9.6754e+005	2.3711e+011

2.13.2. Punching Shear Results

Support	V _u kN	Comb	Pat	v _u N/mm ²	ΦV _c N/mm ²
1	266.49	U1	All	0.275	0.970
2	644.98	U1	All	0.394	0.895
3	644.98	U1	All	0.394	0.895
4	266.49	U1	All	0.275	0.970

2.14. Integrity Reinforcement at Supports

Notes:

The sum of bottom reinforcement crossing the perimeter of the support on all sides shall not be less than the below listed values.

Support	V _{sb} kN	A _{sb} mm ²
1	234.84	1174
2	529.74	2649
3	529.74	2649
4	234.84	1174

2.15. Material TakeOff

2.15.1. Reinforcement in the Direction of Analysis

Top Bars	547.0 kg	<=>	25.21 kg/m	<=>	3.820 kg/m ²
Bottom Bars	590.6 kg	<=>	27.22 kg/m	<=>	4.124 kg/m ²
Stirrups	0.0 kg	<=>	0.00 kg/m	<=>	0.000 kg/m ²
Total Steel	1137.7 kg	<=>	52.43 kg/m	<=>	7.944 kg/m ²
Concrete	32.3 m ³	<=>	1.49 m ³ /m	<=>	0.225 m ³ /m ²

3. Deflection Results: Summary

3.1. Section Properties

3.1.1. Frame Section Properties

Notes:

M+ve values are for positive moments (tension at bottom face).

M-ve values are for negative moments (tension at top face).

Span Zone	M _{..ve}			M _{..ve}		
	I _g mm ⁴	I _{cr} mm ⁴	M _{cr} kNm	I _g mm ⁴	I _{cr} mm ⁴	M _{cr} kNm
1 Left	5.8564e+009	0	79.86	5.8564e+009	7.5966e+008	-79.86
Midspan	5.8564e+009	0	79.86	5.8564e+009	8.8091e+008	-79.86
Right	7.9149e+009	0	75.66	7.9149e+009	1.3875e+009	-98.87
2 Left	7.9149e+009	6.0881e+008	75.66	7.9149e+009	1.3875e+009	-98.87
Midspan	5.8564e+009	7.5966e+008	79.86	5.8564e+009	0	-79.86
Right	7.9149e+009	6.0881e+008	75.66	7.9149e+009	1.6087e+009	-98.87
3 Left	7.9149e+009	6.0881e+008	75.66	7.9149e+009	1.6087e+009	-98.87
Midspan	5.8564e+009	7.5966e+008	79.86	5.8564e+009	0	-79.86

Span Zone	M_{-vs}			M_{-vs}		
	I_g mm ⁴	I_{cr} mm ⁴	M_{cr} kNm	I_g mm ⁴	I_{cr} mm ⁴	M_{cr} kNm
Right	7.9149e+009	6.0881e+008	75.66	7.9149e+009	1.6087e+009	-98.87
4 Left	7.9149e+009	6.0881e+008	75.66	7.9149e+009	1.6087e+009	-98.87
Midspan	5.8564e+009	7.5966e+008	79.86	5.8564e+009	0	-79.86
Right	7.9149e+009	6.0881e+008	75.66	7.9149e+009	1.3875e+009	-98.87
5 Left	7.9149e+009	0	75.66	7.9149e+009	1.3875e+009	-98.87
Midspan	5.8564e+009	0	79.86	5.8564e+009	8.8091e+008	-79.86
Right	5.8564e+009	0	79.86	5.8564e+009	7.5966e+008	-79.86

3.1.2. Frame Effective Section Properties

Span Zone	Weight	Load Level					
		Dead		Sustained		Dead+Live	
		M_{max} kNm	I_e mm ⁴	M_{max} kNm	I_e mm ⁴	M_{max} kNm	I_e mm ⁴
1 Right	1.000	-2.95	7.9149e+009	-2.95	7.9149e+009	-2.95	7.9149e+009
Span Avg	----	----	7.9149e+009	----	7.9149e+009	----	7.9149e+009
2 Left	0.250	88.25	5.212e+009	88.25	5.212e+009	132.58	1.9667e+009
Middle	0.500	96.33	3.6639e+009	96.33	3.6639e+009	144.66	1.6172e+009
Right	0.250	-229.36	2.1138e+009	-229.36	2.1138e+009	-343.79	1.7587e+009
Span Avg	----	----	3.6634e+009	----	3.6634e+009	----	1.7399e+009
3 Left	0.250	-234.39	2.082e+009	-234.39	2.082e+009	-351.24	1.7493e+009
Middle	0.500	100.34	3.3296e+009	100.34	3.3296e+009	150.55	1.5205e+009
Right	0.250	-234.39	2.082e+009	-234.39	2.082e+009	-351.24	1.7493e+009
Span Avg	----	----	2.7058e+009	----	2.7058e+009	----	1.6349e+009
4 Left	0.250	-229.36	2.1138e+009	-229.36	2.1138e+009	-343.79	1.7587e+009
Middle	0.500	96.33	3.6639e+009	96.33	3.6639e+009	144.66	1.6172e+009
Right	0.250	88.25	5.212e+009	88.25	5.212e+009	132.58	1.9667e+009
Span Avg	----	----	3.6634e+009	----	3.6634e+009	----	1.7399e+009
5 Left	1.000	-2.95	7.9149e+009	-2.95	7.9149e+009	-2.95	7.9149e+009
Span Avg	----	----	7.9149e+009	----	7.9149e+009	----	7.9149e+009

3.1.3. Strip Section Properties at Midspan

Notes:

Load distribution factor, LDL, averages moment distribution factors listed in Design Results.

Ratio refers to proportion of strip to frame deflections under fix-end conditions.

Span	Column Strip			Middle Strip		
	I_g mm ⁴	LDf	Ratio	I_g mm ⁴	LDf	Ratio
1	2.9282e+009	0.800	1.600	2.9282e+009	0.200	0.400
2	2.9282e+009	0.756	1.513	2.9282e+009	0.244	0.488
3	2.9282e+009	0.712	1.425	2.9282e+009	0.288	0.575
4	2.9282e+009	0.756	1.513	2.9282e+009	0.244	0.488
5	2.9282e+009	0.800	1.600	2.9282e+009	0.200	0.400

3.2. Instantaneous Deflections

3.2.1. Extreme Instantaneous Frame Deflections and Corresponding Locations

Span	Direction	Value	Units	Live				Total	
				Dead	Sustained	Unsustained	Total	Sustained	Dead+Live
1	Down	Def	mm	---	---	---	---	---	---
		Loc	m	---	---	---	---	---	---
	Up	Def	mm	-0.30	---	-0.23	-0.23	-0.30	-0.54
		Loc	m	0.000	---	0.000	0.000	0.000	0.000

Span	Direction	Value	Units	Dead	Live			Total	
					Sustained	Unsustained	Total	Sustained	Dead+Live
2	Down	Def	mm	2.86	---	4.67	4.67	2.86	7.52
		Loc	m	3.089	---	3.238	3.238	3.089	3.163
	Up	Def	mm	0.00	---	-0.02	-0.02	0.00	-0.02
		Loc	m	6.625	---	6.400	6.400	6.625	6.550
3	Down	Def	mm	4.84	---	6.67	6.67	4.84	11.51
		Loc	m	3.750	---	3.750	3.750	3.750	3.750
	Up	Def	mm	---	---	---	---	---	---
		Loc	m	---	---	---	---	---	---
4	Down	Def	mm	2.86	---	4.67	4.67	2.86	7.52
		Loc	m	3.611	---	3.462	3.462	3.611	3.537
	Up	Def	mm	0.00	---	-0.02	-0.02	0.00	-0.02
		Loc	m	0.120	---	0.300	0.300	0.120	0.180
5	Down	Def	mm	---	---	---	---	---	---
		Loc	m	---	---	---	---	---	---
	Up	Def	mm	-0.30	---	-0.23	-0.23	-0.30	-0.54
		Loc	m	0.400	---	0.400	0.400	0.400	0.400

3.2.2. Extreme Instantaneous Column Strip Deflections and Corresponding Locations

Span	Direction	Value	Units	Dead	Live			Total	
					Sustained	Unsustained	Total	Sustained	Dead+Live
1	Down	Def	mm	---	---	---	---	---	---
		Loc	m	---	---	---	---	---	---
	Up	Def	mm	-0.30	---	-0.23	-0.23	-0.30	-0.54
		Loc	m	0.000	---	0.000	0.000	0.000	0.000
2	Down	Def	mm	4.00	---	6.83	6.83	4.00	10.82
		Loc	m	3.163	---	3.238	3.238	3.163	3.238
	Up	Def	mm	0.00	---	-0.01	-0.01	0.00	-0.01
		Loc	m	6.625	---	6.475	6.475	6.625	6.625
3	Down	Def	mm	6.82	---	9.39	9.39	6.82	16.22
		Loc	m	3.750	---	3.750	3.750	3.750	3.750
	Up	Def	mm	---	---	---	---	---	---
		Loc	m	---	---	---	---	---	---
4	Down	Def	mm	4.00	---	6.83	6.83	4.00	10.82
		Loc	m	3.537	---	3.462	3.462	3.537	3.462
	Up	Def	mm	0.00	---	-0.01	-0.01	0.00	-0.01
		Loc	m	0.060	---	0.180	0.180	0.060	0.120
5	Down	Def	mm	---	---	---	---	---	---
		Loc	m	---	---	---	---	---	---
	Up	Def	mm	-0.30	---	-0.23	-0.23	-0.30	-0.54
		Loc	m	0.400	---	0.400	0.400	0.400	0.400

3.2.3. Extreme Instantaneous Middle Strip Deflections and Corresponding Locations

Span	Direction	Value	Units	Dead	Live			Total	
					Sustained	Unsustained	Total	Sustained	Dead+Live
1	Down	Def	mm	---	---	---	---	---	---
		Loc	m	---	---	---	---	---	---
	Up	Def	mm	-0.30	---	-0.23	-0.23	-0.30	-0.54
		Loc	m	0.000	---	0.000	0.000	0.000	0.000
2	Down	Def	mm	1.74	---	2.51	2.51	1.74	4.24
		Loc	m	2.940	---	3.089	3.089	2.940	3.014
	Up	Def	mm	-0.01	---	-0.03	-0.03	-0.01	-0.03
		Loc	m	6.550	---	6.330	6.330	6.550	6.400
3	Down	Def	mm	2.86	---	3.94	3.94	2.86	6.80

Span	Direction	Value	Units	Dead	Live			Total	
					Sustained	Unsustained	Total	Sustained	Dead+Live
4	Up	Loc	m	3.750	---	3.750	3.750	3.750	3.750
		Def	mm	---	---	---	---	---	---
	Down	Loc	m	---	---	---	---	---	---
		Def	mm	1.74	---	2.51	2.51	1.74	4.24
5	Up	Loc	m	3.760	---	3.611	3.611	3.760	3.686
		Def	mm	-0.01	---	-0.03	-0.03	-0.01	-0.03
	Down	Loc	m	0.180	---	0.370	0.370	0.180	0.300
		Def	mm	---	---	---	---	---	---
	Up	Loc	m	---	---	---	---	---	---
		Def	mm	-0.30	---	-0.23	-0.23	-0.30	-0.54
		Loc	m	0.400	---	0.400	0.400	0.400	0.400

3.3. Long-term Deflections

3.3.1. Long-term Column Strip Deflection Factors

Notes:

Deflection multiplier, Lambda, depends on moment sign at sustained load level and Rho' in given zone.
Rho' is assumed zero because Compression Reinforcement option is NOT selected in Solve Options.

Time dependant factor for sustained loads = 2.000

Span Zone	M _{-ve}					M _{-ve}				
	A _{s,top} mm ²	b mm	d mm	Rho' %	Lambda	A _{s,bot} mm ²	b mm	d mm	Rho' %	Lambda
1 Right	---	---	---	0.000	2.000	---	---	---	0.000	2.000
2 Midspan	---	---	---	0.000	2.000	---	---	---	0.000	2.000
3 Midspan	---	---	---	0.000	2.000	---	---	---	0.000	2.000
4 Midspan	---	---	---	0.000	2.000	---	---	---	0.000	2.000
5 Left	---	---	---	0.000	2.000	---	---	---	0.000	2.000

3.3.2. Long-term Middle Strip Deflection Factors

Notes:

Deflection multiplier, Lambda, depends on moment sign at sustained load level and Rho' in given zone.
Rho' is assumed zero because Compression Reinforcement option is NOT selected in Solve Options.

Time dependant factor for sustained loads = 2.000

Span Zone	M _{-ve}					M _{-ve}				
	A _{s,top} mm ²	b mm	d mm	Rho' %	Lambda	A _{s,bot} mm ²	b mm	d mm	Rho' %	Lambda
1 Right	---	---	---	0.000	2.000	---	---	---	0.000	2.000
2 Midspan	---	---	---	0.000	2.000	---	---	---	0.000	2.000
3 Midspan	---	---	---	0.000	2.000	---	---	---	0.000	2.000
4 Midspan	---	---	---	0.000	2.000	---	---	---	0.000	2.000
5 Left	---	---	---	0.000	2.000	---	---	---	0.000	2.000

3.3.3. Extreme Long-term Column Strip Deflections and Corresponding Locations

Notes:

Incremental deflections due to creep and shrinkage (cs) based on sustained load level values.

Incremental deflections after partitions are installed can be estimated by deflections due to:

- creep and shrinkage plus unsustained live load (cs+lu), if live load applied before partitions,
- creep and shrinkage plus live load (cs+l), if live load applied after partitions.

Total deflections consist of dead, live, and creep and shrinkage deflections.

Span	Direction	Value	Units	cs	cs+lu	cs+l	Total
1	Down	Def	mm	---	---	---	---
		Loc	m	---	---	---	---

Span	Direction	Value	Units	cs	cs+lu	cs+l	Total
2	Up	Def	mm	-0.61	-0.84	-0.84	-1.14
		Loc	m	0.000	0.000	0.000	0.000
	Down	Def	mm	7.99	14.82	14.82	18.81
		Loc	m	3.163	3.238	3.238	3.238
3	Up	Def	mm	-0.01	-0.01	-0.01	-0.02
		Loc	m	6.625	6.625	6.625	6.625
	Down	Def	mm	13.64	23.04	23.04	29.86
		Loc	m	3.750	3.750	3.750	3.750
4	Up	Def	mm	---	---	---	---
		Loc	m	---	---	---	---
	Down	Def	mm	7.99	14.82	14.82	18.81
		Loc	m	3.537	3.462	3.462	3.462
5	Up	Def	mm	-0.01	-0.01	-0.01	-0.01
		Loc	m	0.060	0.120	0.120	0.060
	Down	Def	mm	---	---	---	---
		Loc	m	---	---	---	---
	Up	Def	mm	-0.61	-0.84	-0.84	-1.14
		Loc	m	0.400	0.400	0.400	0.400

3.3.4. Extreme Long-term Middle Strip Deflections and Corresponding Locations

Notes:

Incremental deflections due to creep and shrinkage (cs) based on sustained load level values.

Incremental deflections after partitions are installed can be estimated by deflections due to:

- creep and shrinkage plus unsustained live load (cs+lu), if live load applied before partitions,

- creep and shrinkage plus live load (cs+l), if live load applied after partitions.

Total deflections consist of dead, live, and creep and shrinkage deflections.

Span	Direction	Value	Units	cs	cs+lu	cs+l	Total
1	Down	Def	mm	---	---	---	---
		Loc	m	---	---	---	---
	Up	Def	mm	-0.61	-0.84	-0.84	-1.14
		Loc	m	0.000	0.000	0.000	0.000
2	Down	Def	mm	3.47	5.98	5.98	7.71
		Loc	m	2.940	3.014	3.014	3.014
	Up	Def	mm	-0.01	-0.04	-0.04	-0.04
		Loc	m	6.550	6.475	6.475	6.475
3	Down	Def	mm	5.71	9.65	9.65	12.51
		Loc	m	3.750	3.750	3.750	3.750
	Up	Def	mm	---	---	---	---
		Loc	m	---	---	---	---
4	Down	Def	mm	3.47	5.98	5.98	7.71
		Loc	m	3.760	3.686	3.686	3.686
	Up	Def	mm	-0.01	-0.04	-0.04	-0.04
		Loc	m	0.180	0.240	0.240	0.240
5	Down	Def	mm	---	---	---	---
		Loc	m	---	---	---	---
	Up	Def	mm	-0.61	-0.84	-0.84	-1.14
		Loc	m	0.400	0.400	0.400	0.400

6. Summary and Comparison of Design Results

		Reference (DDM)	Hand (EFM)	spSlab
Exterior Span				
Frame Strip	Exterior Negative*	116.0	160.2	153.9
	Positive	231.0	184.6	192.9
	Interior Negative*	312.0	363.2	356.4
Interior Span				
Frame Strip	Interior Negative*	370.0	373.8	364.9
	Positive	201.0	198.0	200.7

*Negative moments are taken at the faces of supports

Span Location	Reinforcement Provided for Flexure			Additional Reinforcement Provided for Unbalanced Moment Transfer			Total Reinforcement Provided			
	Reference	Hand	spSlab	Reference	Hand	spSlab	Reference	Hand	spSlab	
Exterior Span										
Column Strip	Exterior Negative	Not Provided	16-15M	16-15M	Not Provided	---	---	Not Provided	16-15M	16-15M
	Positive	11-15M	10-15M	10-15M	n/a	n/a	n/a	11-15M	10-15M	10-15M
	Interior Negative	Not Provided	20-15M	21-15M	Not Provided	---	---	Not Provided	20-15M	21-15M
Middle Strip	Interior Negative	Not Provided	8-15M	8-15M	n/a	n/a	n/a	Not Provided	8-15M	8-15M
	Positive	8-15M	8-15M	8-15M	n/a	n/a	n/a	8-15M	8-15M	8-15M
	Interior Negative	Not Provided	8-15M	8-15M	n/a	n/a	n/a	Not Provided	8-15M	8-15M
Interior Span										
Column Strip	Negative	24-15M	20-15M	21-15M	Not Provided	---	---	24-15M	20-15M	21-15M
	Positive	9-15M	10-15M	10-15M	n/a	n/a	n/a	9-15M	10-15M	10-15M
Middle Strip	Negative	4-15M	8-15M	8-15M	n/a	n/a	n/a	4-15M	8-15M	8-15M
	Positive	8-15M	8-15M	8-15M	n/a	n/a	n/a	8-15M	8-15M	8-15M

Table 5 and table 6 compare the results from reference using DDM with the hand solution and spSlab results using EFM. Differences between the reference results and the hand/spSlab results are mainly attributed to the use of different analysis techniques (DDM by reference and EFM by hand and spSlab).

The limitations of the DDM required the reference to make several assumptions to make the use of DDM valid and to simplify the calculations:

- Reference excluded the weight of the exterior cladding panels which impacts the shear values at the exterior supports.

- Reference excluded the slab projection that supports the cladding panels which impacts the shear and moments at the exterior supports.
- Reference uses an averaged reinforcement effective depth for shear calculations. This lowers the slab one-way and two-way shear capacity.
- Using the tributary method in the reference and assuming that half of the total load is transferred to the interior column is not exact and may underestimate the loads at the span ends.
- Reference uses an assumed internal lever arm of 0.9d which leads to approximate moment resistance values and may require higher steel reinforcement.
- Reference uses the lower value for the percentage of moment distributed over column and middle strips while hand/spSlab uses the average value.

Span	$V_f @ d_v$, kN		$V_f @ \text{drop panel}$, kN		$V_c @ d_v$, kN		$V_c @ \text{drop panel}$, kN	
	Hand	spSlab	Hand	spSlab	Hand	spSlab	Hand	spSlab
Exterior	307.6	308.5	258.2	256.2	828.8	828.1	756.8	758.1
Interior	307.0	313.2	251.7	261.0	828.8	828.1	756.8	758.1

Support	b_1 , mm		b_2 , mm		b_o , mm		V_f , kN		c_{AB} , mm	
	Hand	spSlab	Hand	spSlab	Hand	spSlab	Hand	spSlab	Hand	spSlab
Exterior	822	822	644	644	2288	2288	278.7	301.0	295.3	295.3
Interior	844	844	644	644	2976	2976	704.0	705.9	422.0	422.0

Support	J_c , mm ⁴		γ_v		M_{umb} , kN.m		v_f , MPa		v_c , MPa	
	Hand	spSlab	Hand	spSlab	Hand	spSlab	Hand	spSlab	Hand	spSlab
Exterior	4.36×10 ¹⁰	4.36×10 ¹⁰	0.430	0.430	206.7	194.1	1.100	1.103	1.235	1.235
Interior	8.25×10 ¹⁰	8.25×10 ¹⁰	0.433	0.433	11.5	9.9	0.990	0.994	1.235	1.235

Support	b_1 , mm		b_2 , mm		b_o , mm		V_f , kN		c_{AB} , mm	
	Hand	spSlab	Hand	spSlab	Hand	spSlab	Hand	spSlab	Hand	spSlab
Exterior	1493.5	1493.5	2187	2187	5174	5174	234.4	266.5	431.1	413.1
Interior	2187	2187	2187	2187	8748	8748	635.3	645.0	1093.5	1093.5

Support	J_c , mm ⁴		γ_v		M_{umb} , kN.m		v_f , MPa		v_c , MPa	
	Hand	spSlab	Hand	spSlab	Hand	spSlab	Hand	spSlab	Hand	spSlab
Exterior	23.7×10 ¹⁰	23.7×10 ¹⁰	0.355	---	86.8	---	0.298	0.275	0.970	0.970
Interior	131×10 ¹⁰	131×10 ¹⁰	0.400	---	11.5	---	0.392	0.394	0.895	0.895

In the tables above, the results are in close or exact agreement with the automated analysis and design results obtained from the spSlab model. Note that the two-way shear stress calculations around drop panels (in spSlab) do not include the term for unbalanced moment since the program treats the drop panels as thickened portion of the slab and are not considered as a support. On the other hand, the CSA code treats the drop panel as a support and therefore, the shear stress from the unbalanced moment is included in the punching shear calculations as shown in the hand solution.

7. Conclusions & Observations

7.1. One-Way Shear Distribution to Slab Strips

In one-way shear checks above, shear is distributed uniformly along the width of the design strip (6.6 m). [StructurePoint](#) finds it necessary sometimes to allocate the one-way shears with the same proportion moments are distributed to column and middle strips.

[spSlab](#) allows the one-way shear check using two approaches: 1) calculating the one-way shear capacity using the average slab thickness and comparing it with the total factored one-shear load as shown in the hand calculations above; 2) distributing the factored one-way shear forces to the column and middle strips and comparing it with the shear capacity of each strip as illustrated in the following figures. An engineering judgment is needed to decide which approach to be used.

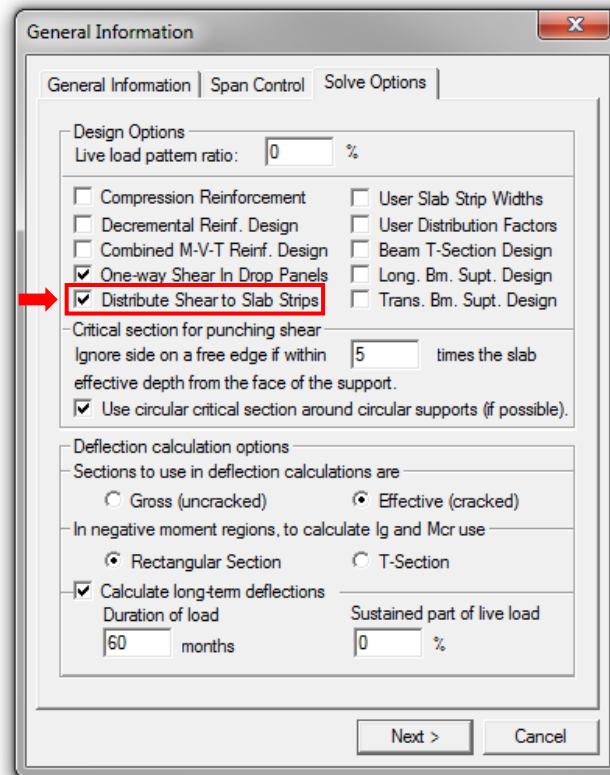

Figure 17 – Distributing Shear to Column and Middle Strips ([spSlab](#) Input)

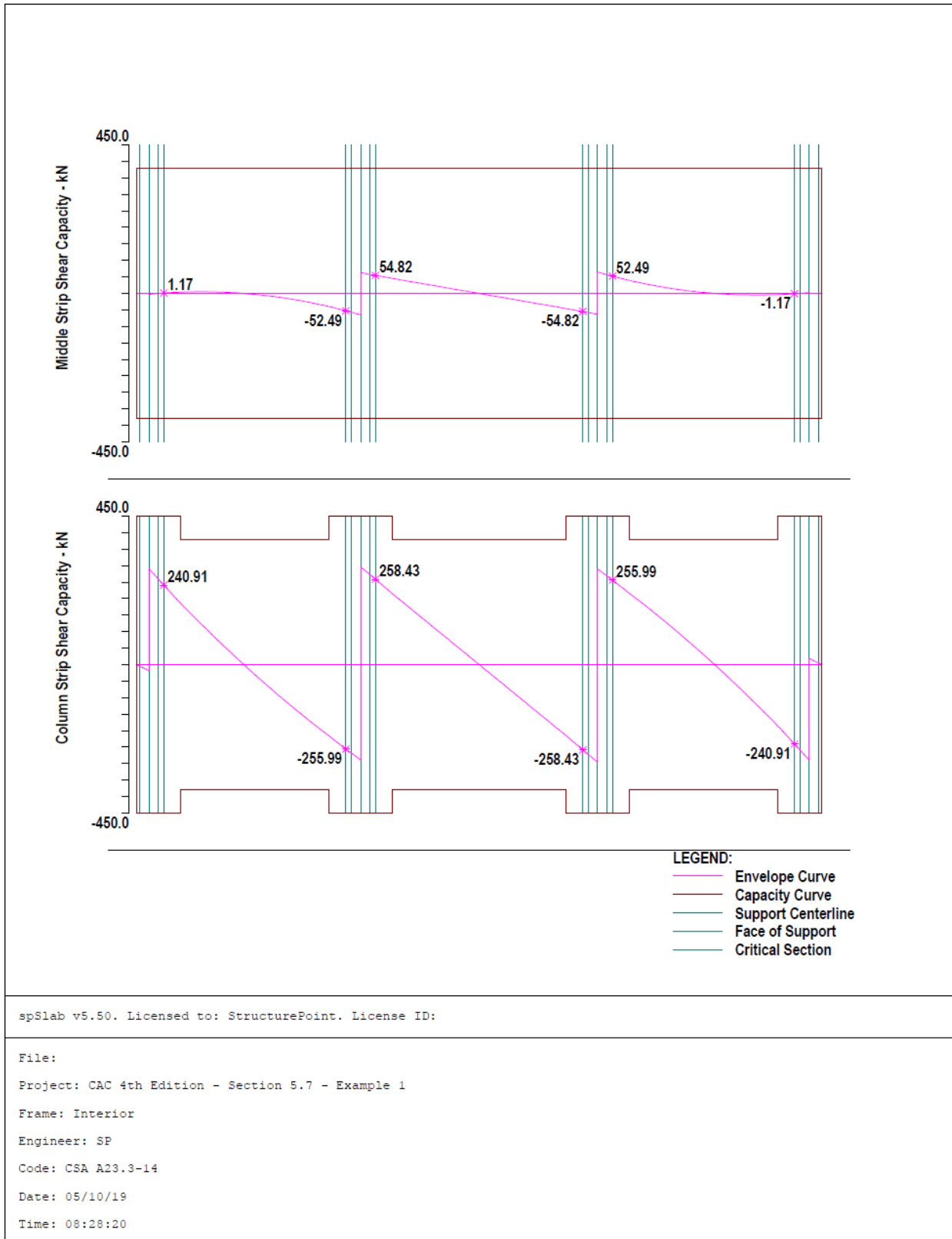

Figure 18 – Distributed Column and Middle Strip Shear Force Diagram (spSlab Output)

1.1. Slab Shear Capacity

Span Strip	b	d _v	β	V _{ratio}	ΦV _c	V _u	X _u
	mm	mm			kN	kN	m
1 Column	3300	168	0.210	1.000	379.05	0.00	0.00
	3300	199	0.210	1.000	449.08	0.00	0.00
Middle	3300	168	0.210	0.000	379.05	0.00	0.00
	3300	168	0.210	0.000	379.05	0.00	0.00
2 Column	3300	199	0.210	0.995	449.08	240.91	0.47
	3300	168	0.210	0.845	379.05	216.54	5.70
Middle	3300	199	0.210	0.830	449.08	255.99	6.23
	3300	168	0.210	0.020	379.05	3.81	1.00
3 Column	3300	168	0.210	0.155	379.05	39.70	5.70
	3300	168	0.210	0.170	379.05	52.49	6.23
Middle	3300	199	0.210	0.825	449.08	258.43	0.47
	3300	168	0.210	0.825	379.05	215.32	1.00
4 Column	3300	199	0.210	0.825	449.08	258.43	7.03
	3300	168	0.210	0.175	379.05	54.82	0.47
Middle	3300	168	0.210	0.175	379.05	45.67	1.00
	3300	168	0.210	0.175	379.05	54.82	7.03
5 Column	3300	199	0.210	0.830	449.08	255.99	0.47
	3300	168	0.210	0.845	379.05	216.54	1.00
Middle	3300	199	0.210	0.995	449.08	240.91	6.23
	3300	168	0.210	0.170	379.05	52.49	0.47
6 Column	3300	168	0.210	0.155	379.05	39.70	1.00
	3300	168	0.210	0.020	379.05	3.81	5.70
7 Column	3300	199	0.210	1.000	449.08	0.00	0.40
	3300	168	0.210	1.000	379.05	0.00	0.40
8 Middle	3300	168	0.210	0.000	379.05	0.00	0.40
	3300	168	0.210	0.000	379.05	0.00	0.40

Figure 19 – Tabulated Shear Force & Capacity at Critical Sections (spSlab Output)

7.2. Two-Way Concrete Slab Analysis Methods

A slab system can be analyzed and designed by any procedure satisfying equilibrium and geometric compatibility. Three established methods are widely used. The requirements for two of them are described in detail in CSA A.23.3-14 Clause 13.

Direct Design Method (DDM) is an approximate method and is applicable to two-way slab concrete floor systems that meet the stringent requirements of CSA A.23.3-14 (13.9.1). In many projects, however, these requirements limit the usability of the Direct Design Method significantly.

The Elastic Frame Method (EFM) does not have the limitations of DDM. It requires more accurate analysis methods that, depending on the size and geometry can prove to be long, tedious, and time-consuming.

StructurePoint's [spSlab](#) software program solution utilizes the EFM to automate the process providing considerable time-savings in the analysis and design of two-way slab systems as compared to hand solutions using DDM or EFM.

Finite Element Method (FEM) is another method for analyzing reinforced concrete slabs, particularly useful for irregular slab systems with variable thicknesses, openings, and other features not permissible in DDM or EFM. Many reputable commercial FEM analysis software packages are available on the market today such as [spMats](#). Using FEM requires critical understanding of the relationship between the actual behavior of the structure and the numerical simulation since this method is an approximate numerical method. The method is based on several assumptions and the operator has a great deal of decisions to make while setting up the model and applying loads and boundary conditions. The results obtained from FEM models should be verified to confirm their suitability for design and detailing of concrete structures.

The following table shows a general comparison between the DDM, EFM and FEM. This table covers general limitations, drawbacks, advantages, and cost-time efficiency of each method where it helps the engineer in deciding which method to use based on the project complexity, schedule, and budget.

Applicable CSA A23.3-14 Provision	Limitations/Applicability	Concrete Slab Analysis Method		
		DDM (Hand)	EFM (Hand//spSlab)	FEM (spMats)
13.8.1.1 13.9.1.1	Panels shall be rectangular, with ratio of longer to shorter panel dimensions, measured center-to-center supports, not exceed 2.	☑	☑	
13.8.1.1 13.9.1.1	For a panel with beams between supports on all sides, slab-to-beam stiffness ratio shall be satisfied for beams in the two perpendicular directions.	☑	☑	
13.8.1.1 13.9.1.1	Column offset shall not exceed 20% of the span in direction of offset from either axis between centerlines of successive columns	☑	☑	
13.8.1.1 13.9.1.1	The reinforcement is placed in an orthogonal grid.	☑	☑	
13.9.1.2	Minimum of three continuous spans in each direction	☑		
13.9.1.3	Successive span lengths measured center-to-center of supports in each direction shall not differ by more than one-third the longer span	☑		
13.9.1.4	All loads shall be due to gravity only	☑		
13.9.1.4	All loads shall be uniformly distributed over an entire panel (q_f)	☑		
13.9.1.4	Factored live load shall not exceed two times the factored dead load	☑		
13.10.6	Structural integrity steel detailing	☑	☑	☑
13.10.10	Openings in slab systems	☑	☑	☑
8.2	Concentrated loads	Not permitted	☑	☑
13.8.4.1	Live load arrangement (Load Patterning)	Not required	Required	Engineering judgment required based on modeling technique
13.10.2*	Reinforcement for unbalanced slab moment transfer to column (M_{sc})	Moments @ support face	Moments @ support centerline	Engineering judgment required based on modeling technique
13.8.2	Irregularities (i.e. variable thickness, non-prismatic, partial bands, mixed systems, support arrangement, etc.)	Not permitted	Engineering judgment required	Engineering judgment required
Complexity		Low	Average	Complex to very complex
Design time/costs		Fast	Limited	Unpredictable/Costly
Design Economy		Conservative (see detailed comparison with spSlab output)	Somewhat conservative	Unknown - highly dependent on modeling assumptions: 1. Linear vs. non-linear 2. Isotropic vs non-isotropic 3. Plate element choice 4. Mesh size and aspect ratio 5. Design & detailing features
General (Drawbacks)		Very limited applications	Limited geometry	Limited guidance non-standard application (user dependent). Required significant engineering judgment
General (Advantages)		Very limited analysis is required	Detailed analysis is required or via software (e.g. spSlab)	Unlimited applicability to handle complex situations permissible by the features of the software used (e.g. spMats)

* The unbalanced slab moment transferred to the column M_{sc} (M_{unb}) is the difference in slab moment on either side of a column at a specific joint. In DDM only moments at the face of the support are calculated and are also used to obtain M_{sc} (M_{unb}). In EFM where a frame analysis is used, moments at the column center line are used to obtain M_{sc} (M_{unb}).